



AIR CLEANER, AIR CLEANER LIGHT BRACKET & ACCESSORIES



Quality.

Innovation.

Design.

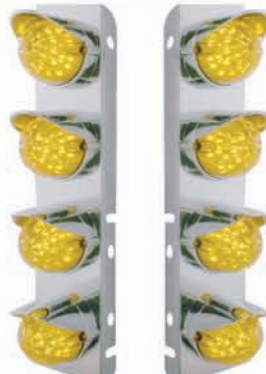

MISSION STATEMENT

Here at United Pacific, we are dedicated to providing today's drivers with innovative and exciting products that deliver exceptional performance and value. Because United Pacific's continuing success depends on our customer's satisfaction, we constantly push our designers and engineers to upgrade our facilities and processes in order to bring products of superior quality and reliability to the market. We at United Pacific promise to continue our passionate pursuit to be the first in

QUALITY, INNOVATION AND DESIGN.

QUALITY

With over 30 years of experience in the heavy duty trucking industry, United Pacific Industries understand the rigors and stresses that our products are subjected to on the road. It is our mission to provide our customers with products of superior quality and reliability. In achieving this goal, United Pacific only partners with manufacturing facilities that conforms to our quality control requirements and standards. Our manufacturing partners meet or exceed ISO-9001 requirements. In addition, United Pacific's manufacturing partners must be equipped on site to perform the following quality assurance tests:

AGING TEST

AIR TIGHT TEST

DUST TEST

FLUX TEST

PHOTOMETRIC TEST

PULL FORCE TEST

RAIN TEST

SALT SPRAY TEST

SHOCK TEST

TEMPERATURE TEST

HUMIDITY TEST

VIBRATION TEST

United Pacific's manufacturing partners must maintain a track record of consistent quality and low product failure rate. Furthermore, our internal quality control structure allows us to function as the final quality control station prior to shipping. With the assistance of 3D computer technology, United Pacific can adhere to strict quality control standards during prototype creation and the production process. Our engineers and technicians perform a battery of tests to ensure that our products meet the demands of today's drivers and our goal to be first in quality.

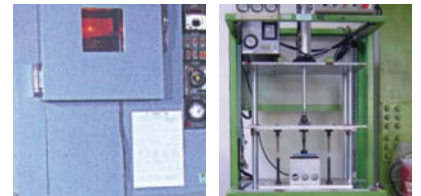



HOW TO ORDER

To order from United Pacific Industries, you must be an authorized dealer, distributor or OEM.

If you are not authorized to stock and sell United Pacific products, you must order through an authorized dealer. Please call 1 (310) 638-5988 for more information.

CONTACT US

United Pacific customer service representatives are available from:

8 am - 4:30 pm PST

Toll Free: 1 (800) 790-6988
 Phone: 1 (310) 638-5988
 Fax: 1 (310) 638-6287
 Email: sales@uapac.com
 Website: www.uapac.com

INNOVATION

Known as the leader in innovation, United Pacific is dedicated to be the first to bring new and exciting products to the market. United Pacific's global expertise allows us to search the globe for new ideas and concepts. Not only do we search the globe for new products, United Pacific invest a significant amount of resources into our own research and development efforts.



With the assistance of advance 3D scanning technology, our engineers and designers can acquire accurate and precise data in seconds. The 3D data allows United Pacific to verify designs, perform quality assurance tests, and reverse engineer with unprecedented speed and accuracy. Digital inspection contributes to the early detection of shape problems, provides rapid feedback on design, and eliminates unnecessary work in downstream processes. Our rapid prototyping facility permits us to have a concept-to-shelf time of less than 5 months.



In addition, United Pacific's 3D printing capabilities permit our designers to have physical models of their design concepts in hours. The physical models allow our designers and marketing staff to evaluate and test the viability of different design ideas. Our rapid prototyping facility allow United Pacific to compress design cycles, improve manufacturing planning, shorten concept-to-shelf time, most importantly, generate new and innovative products.

DESIGN

Located near some of the nation's most progressive automotive design centers, United Pacific established the UP Design Studio in 2002 to consolidate our position as the design leader in the heavy duty trucking industry. UP Design Studio utilizes the latest generation of computer aided design (CAD) and studio/graphic softwares. The design studio is equipped with the newest computers and rapid prototyping systems. In addition, UP Design Studio is staff by graduates from the nation's most prestigious design colleges.



Unlike our competitors, United Pacific's design and manufacturing capabilities mean that we carry more new and original items than our competitors. The establishment of the design studio will enable us to generate even more new products with significant shorter concept-to-shelf time. The reduction in development cost mean that we can develop products utilizing design based development processes. Design based product development allows United Pacific to create new product concepts base on designs incorporating driver demands and needs instead of economic considerations. United Pacific's emphasis on design distinguishes and positions us ahead of our competitors.



Light Emitting Diodes (LED)

Low voltage Operation

A low voltage device, LEDs draw minuscule amount of current from a vehicle's electrical system compare to incandescent devices. Low voltage draw protects and prolongs a vehicle's electrical system.

Instant On

LEDs light up in microseconds. Research conducted by University of Michigan Transportation Research Institute indicates that motorist respond quicker to LEDs than incandescent lights.

Rugged & Durable

Being a solid-state device, LEDs contain no moving parts and filaments to break. Produced with similar technologies as the latest microprocessor, LEDs provide unparalleled reliability and dependability.

Cold Start Capacity

Unlike many light sources in use today, LEDs do not require any special drivers or equipment to operate in extreme cold temperature. Solid State technology allows LEDs to function in inhospitable environments, down to -40°.

WARRANTY

With LEDs (Light Emitting Diodes) rated at 100,000 hour of operation and solid-state construction, United Pacific's LED lights are extremely reliable and durable. United Pacific offers a 10 Year Limited Warranty on most LED lights. Economy LED lights are only covered by a 2 Year Limited Warranty. All LED accessory lights are covered by a 6 Month Limited Warranty.



INVENTORY & SHIPPING

With over \$5.8 million in inventory, United Pacific carries over 8,000 items in our California distribution center. No other company in the heavy duty trucking industry can match United Pacific in the variety and range of in-stock inventories. With an order fill rate of over 98.5%, United Pacific is the largest and most reliable supplier in the industry. Our shipping department ships 96.8% of all orders within 24 hours and 98.9% within 48 hours. United Pacific's vast inventory and prompt shipping has made United Pacific the only source for our customer's chrome and lighting needs.

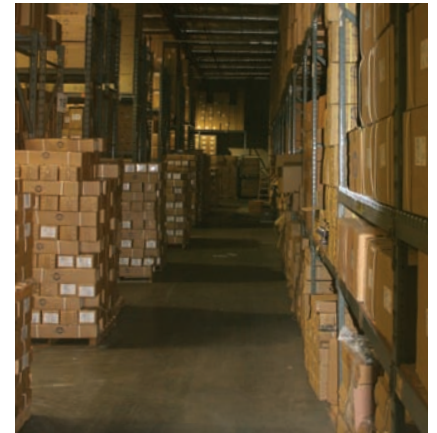

ASSEMBLED IN U.S.A

United Pacific strives to provide today's drivers with innovative and exciting products that deliver exceptional performance and value. With our international background and expertise, we search the globe for the best and most reliable products. However, as an American company, we believe and support the American way of life. Look for the "Assembled in the USA" label on many of our products. Although the components are manufactured overseas, the products, bearing the "Assembled in the USA" labels, are hand assembled with pride in the United States.



WEBSITE

United Pacific strives constantly to improve our existing facilities and procedures. As a part of our continuous improvement process, United Pacific will soon be updating our website. The new website will be even more comprehensive and in-depth. In addition, we will incorporate an online ordering system that will enable our customer to order and receive shipping updates online. The online ordering system will only be available to authorized retailers. The new website is just another example of United Pacific's ceaseless pursuit to be our customer's only source for their chrome and lighting needs.

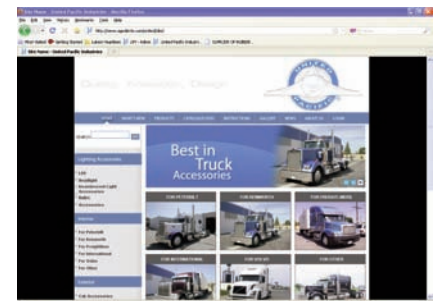

Hard at work for our customers

UNITED PACIFIC SHANGHAI

In 2005, United Pacific opened United Pacific Shanghai. Staffed with 3 quality assessment engineers and 2 logistic support personnel, United Pacific Shanghai serves as United Pacific's quality control and logistics office in China. Located in the commercial center of China, the Shanghai office provides United Pacific with unparalleled access to local markets and suppliers. The open access translates into faster product development and more rigorous quality control standards. The opening of the Shanghai office means that there will be a United Pacific employee hard at work for our customers 24 hours a day in different parts of the world.



UNITED PACIFIC CHROME PLATING

United Pacific's commitment to quality led United Pacific to invest in its own chrome plating facility. With one chrome plating line fully operational and another in construction, the chrome plating plant will ensure that United Pacific products meet our strict quality control standards. Better products mean better sales for United Pacific customers.

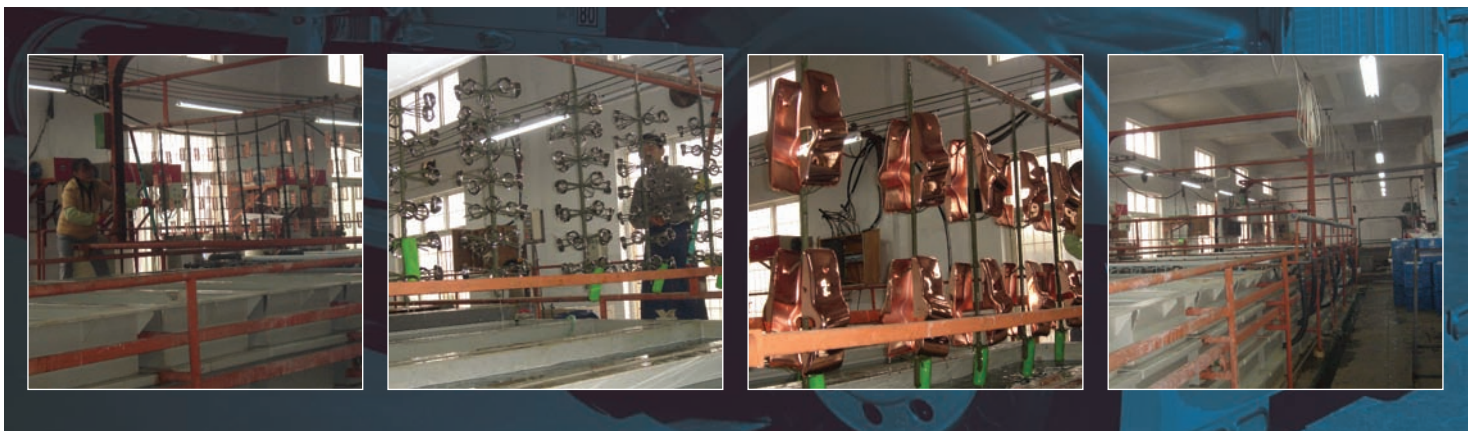

Hard at work for our customers

UNITED PACIFIC JOINT VENTURE

Here at United Pacific, collaboration is at the heart of our business. We partner with manufacturers that are as passionate about well-made and well-designed products as we are. In 2006, United Pacific entered into the ultimate collaboration. United Pacific formed a joint venture with China's largest manufacturer of heavy duty trucking products. The joint venture currently supplies all major American and Canadian aftermarket distributors (including United Pacific competitors) with stainless steel, chrome, and exhaust products. Because of our collaborative approach to product development and manufacturing, we're able to eliminate undue inefficiencies and cost. As a result, United Pacific customers benefit from unique products that are offered at the best possible price and the highest possible quality.



TABLE OF CONTENTS

AIR CLEANER & ACCESSORIES		PAGE
LED Air Cleaner Strap		
Peterbilt LED Air Cleaner Strap		2
LED Rubber Air Cleaner Strap		2
LED Flex Light		2
Air Cleaner		
15" Peterbilt Air Cleaner Kit		3
15" Air Cleaner Housing		3
13" Peterbilt/Kenworth Air Cleaner Housing		3
13" Freightliner Air Cleaner Housing		3
Air Cleaner Bracket & Intake Cover		
15" Peterbilt Air Cleaner Mounting Strap		4
15" Peterbilt Air Cleaner Mounting Plate		4
15" Kenworth Air Cleaner Mounting Bracket		4
2007+ Kenworth T660 LED Air Intake Cover		4
International Air Intake Cover		5
LED FRONT AIR CLEANER LIGHT BRACKET		PAGE
LED Peterbilt Front Air Cleaner Light Bracket		
Large Watermelon LED Peterbilt Front Air Cleaner Light Bracket		6
2" LED Peterbilt Front Air Cleaner Light Bracket		10
2 1/2" LED Peterbilt Front Air Cleaner Light Bracket		13
Medium Watermelon LED Peterbilt Front Air Cleaner Light Bracket		14
LED Kenworth Front Air Cleaner Light Bracket		
2" LED Kenworth Front Air Cleaner Light Bracket		15
Medium Watermelon LED Kenworth Front Air Cleaner Light Bracket		17
LED Freightliner Front Air Cleaner Light Bracket		
2" LED Freightliner Front Air Cleaner Light Bracket		18
Rectangular LED Freightliner Front Air Cleaner Light Bracket		19
"Phantom II" LED Freightliner Front Air Cleaner Light Bracket		20
Medium Watermelon LED Freightliner Front Air Cleaner Light Bracket		20
INCANDESCENT FRONT AIR CLEANER LIGHT BRACKET		PAGE
Incandescent Peterbilt Front Air Cleaner Light Bracket		
Glass Watermelon Peterbilt Front Air Cleaner Bracket		21
2" Incandescent Peterbilt Front Air Cleaner Bracket		21
2 1/2" Incandescent Peterbilt Front Air Cleaner Light Bracket		22
Medium Glass Watermelon Peterbilt Front Air Cleaner Light Bracket		22
Incandescent Kenworth Front Air Cleaner Light Bracket		
2" Incandescent Kenworth Front Air Cleaner Bracket		23
Medium Glass Watermelon Kenworth Front Air Cleaner Light Bracket		23
Incandescent Freightliner Front Air Cleaner Light Bracket		
2" Incandescent Freightliner Front Air Cleaner Bracket		24
Medium Glass Watermelon Freightliner Front Air Cleaner Light Bracket		24
REAR AIR CLEANER LIGHT BRACKET		PAGE
LED Peterbilt Rear Air Cleaner Light Bracket		
2" LED Peterbilt Rear Air Cleaner Light Bracket		25
Incandescent Peterbilt Rear Air Cleaner Light Bracket		
2" Incandescent Peterbilt Rear Air Cleaner Bracket		26
REFERENCE		PAGE
Warranty and Terms		27
Product Index		31

90 LED Stainless Peterbilt Air Cleaner Strap

Description

- Stainless Steel 15" Air Cleaner Strap for Peterbilt with 90 LED Strip Light
- Kit Includes 15" Stainless Steel Air Cleaner Strap, Two 45 LED 35 1/4" Long Flexible LED Strip Light, and Custom Rubber Gasket
- LED Strip Light Available in Amber, Blue, Red, and White
- 1 Kit Only Fits 1 Air Cleaner Strap

Item Number	Description	LED Color	Pack
37526	LED Stainless Air Cleaner Strap	Amber	1 Kit
37527	LED Stainless Air Cleaner Strap	Blue	1 Kit
37528	LED Stainless Air Cleaner Strap	Red	1 Kit
37529	LED Stainless Air Cleaner Strap	White	1 Kit

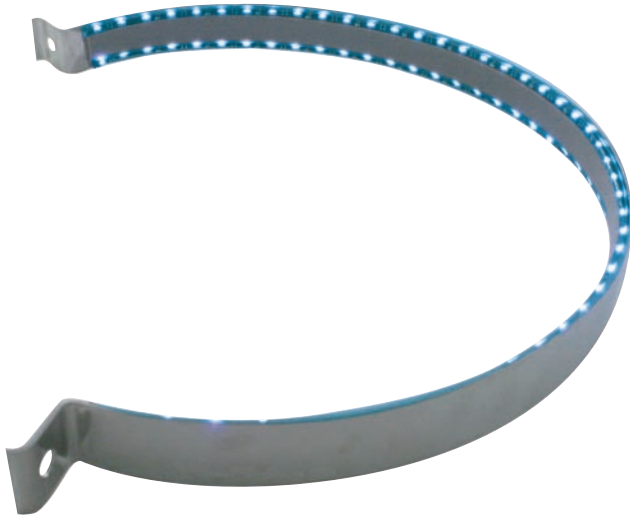

90 LED Rubber Air Cleaner Strap

Description

- 35 1/4" Long Rubber Strap with Two 45 LED 35 1/4" Flexible LED Strip Light
- Rubber Strap and 45 LED Flexible Strip Light can be Cut to Length to Fit Any Size Air Cleaner
- LED Strip Light Available in Amber, Blue, Red, and White
- 1 Kit Only Fits 1 Air Cleaner Strap

Item Number	Description	Color	Pack
37530	LED Rubber Air Cleaner Strap	Amber	1 Kit
37531	LED Rubber Air Cleaner Strap	Blue	1 Kit
37532	LED Rubber Air Cleaner Strap	Red	1 Kit
37533	LED Rubber Air Cleaner Strap	White	1 Kit

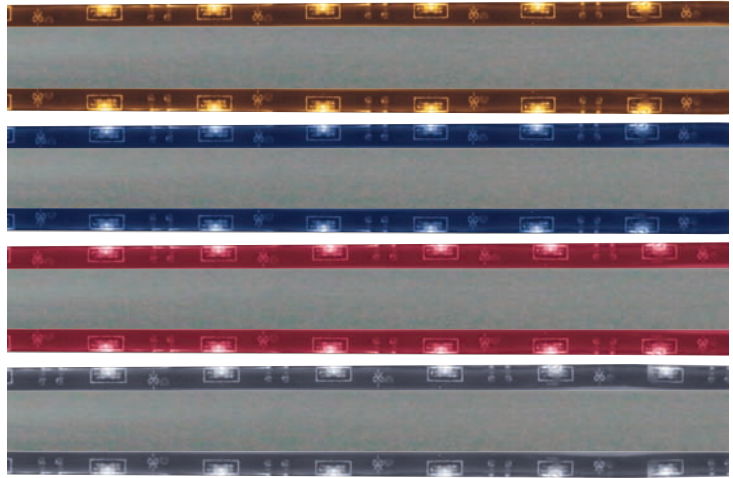

45 LED 35 1/4" Flex Light

Description

- 45 Super Bright LED Auxiliary/Utility Flex Strip Light, Approximately 35 1/4" Long
- Please Specify Wire Exit Position, Wires can Exit on the Left or Right Side When the LED is Pointed Forward

Item Number	LEDs	Wire Exit	Package	Pack
37655	45 Amber	Left	Carded	1 Pc./Card
37656	45 Amber	Right	Carded	1 Pc./Card
37657	45 Blue	Left	Carded	1 Pc./Card
37658	45 Blue	Right	Carded	1 Pc./Card
37623	45 Red	Left	Carded	1 Pc./Card
37624	45 Red	Right	Carded	1 Pc./Card
37659	45 White	Left	Carded	1 Pc./Card
37660	45 White	Right	Carded	1 Pc./Card

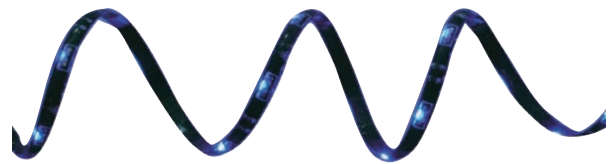

Peterbilt 15" Air Cleaner Rubber Strap with LED Grooves

Description

- Custom Designed Peterbilt 15" Air Cleaner Rubber Gasket with LED Grooves
- Specifically Design to Work with 35 1/4" LED Flex Light

Item Number	Description	Pack
28209	15" Air Cleaner Rubber LED Strap	Bulk = 1 Pc.

15" Stainless Peterbilt Air Cleaner Kit

Description

- 304 Stainless Steel, 15" Vortex Style, Air Cleaner Housing (Item # 28200) with 2 Mounting Straps (Item # 28210B) and 1 Mounting Plate (Item # 28212)
- No Visible Bolt and Nuts on the Exterior, One Long Bolt That Runs Up Through the Middle of the Housing Holding the Air Cleaner Together
- Housing is Approximately 15" x 33 1/2", 7" Diameter Intake

Item Number	Description	Package	Pack
28205	15" Air Cleaner Kit	Boxed	1 Kit/Box

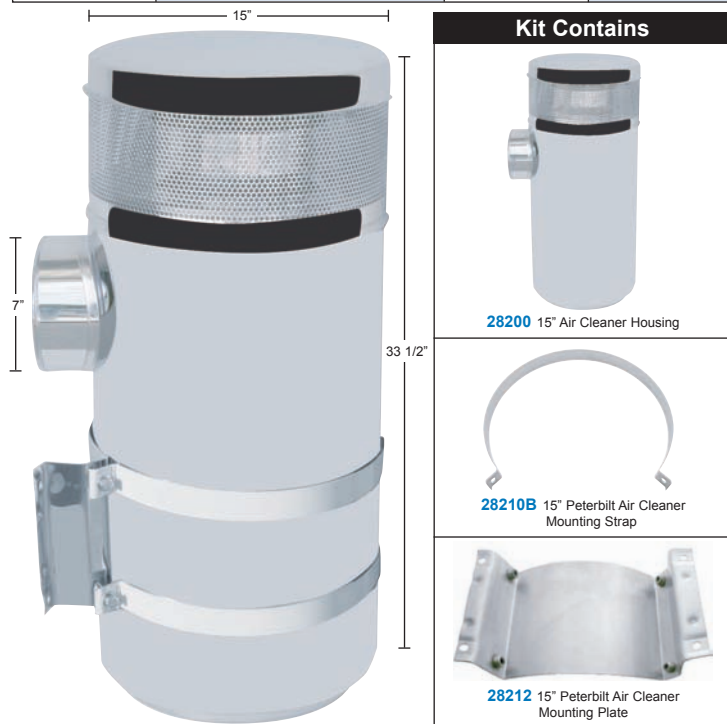

13" Stainless Peterbilt/Kenworth Air Cleaner Housing

Description

- Stainless Steel 13" x 28 1/2" Air Cleaner Housing
- Fits Various Peterbilt and Kenworth Models, 7" Diameter Intake

Item Number	Description	Package	Pack
28202	13" Air Cleaner Housing	Boxed	1 Pc./Box



15" Stainless Air Cleaner Housing

Description

- 304 Stainless Steel 15" Air Cleaner Housing Only, No Air Filter Included
- No Visible Bolts and Nuts on the Exterior, Just One Long Bolt That Runs Up Through the Middle of the Housing Holding the Air Cleaner Together
- Available with OEM Style 4 3/4" Tall Air Filter Screen or Chopped 2 3/4" Screen

Item Number	Description	Style	Pack
28200	15" Air Cleaner Housing	Regular	1 Pc./Box
28201	15" Air Cleaner Housing	Chopped	1 Pc./Box

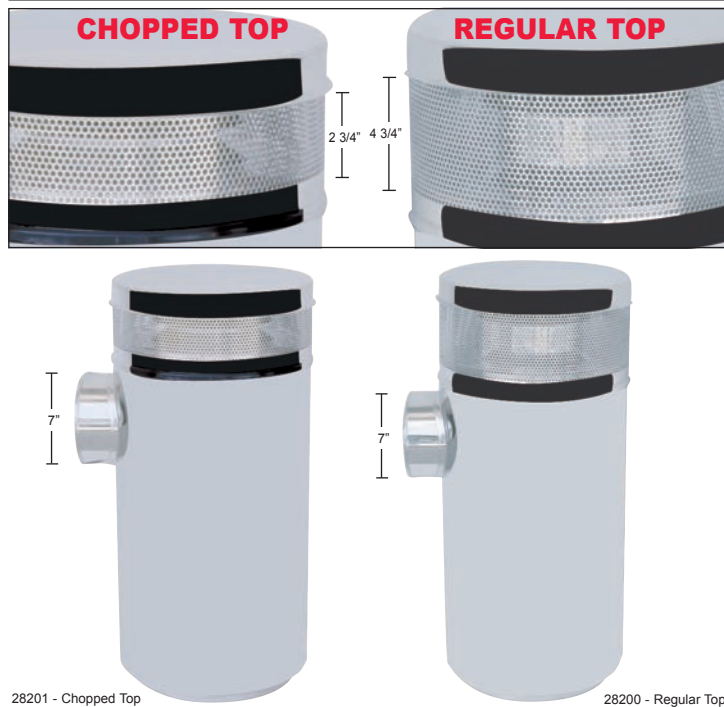

13" Stainless Freightliner Air Cleaner Housing

Description

- Stainless Steel 13" x 29 1/2" Air Cleaner Housing, Donaldson Style
- Fits Various Freightliner Models, 4 3/4" Diameter Intake
- Available in Driver/Left or Passenger/Right Side

Item Number	Description	Side	Pack
28203	13" Air Cleaner Housing	Driver	1 Pc./Box
28204	13" Air Cleaner Housing	Passenger	1 Pc./Box

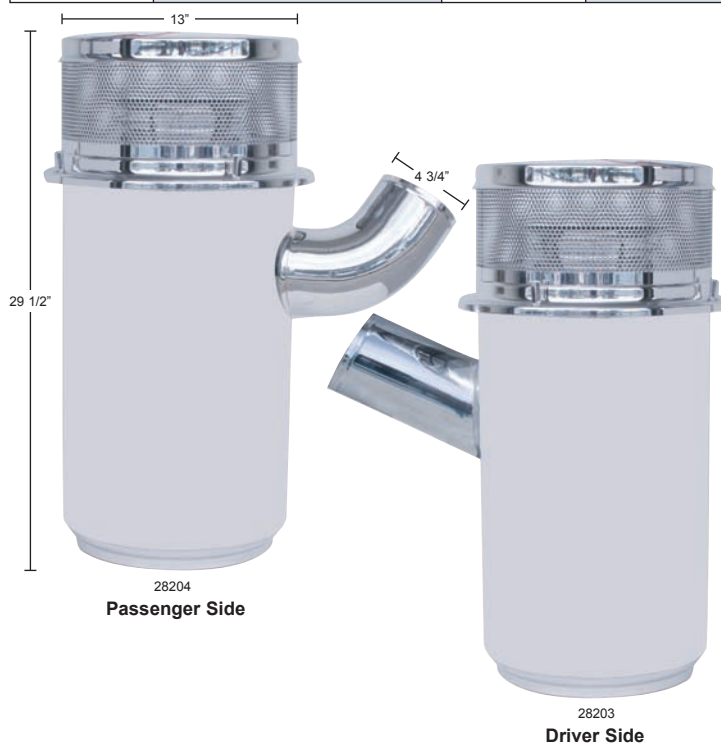

Stainless Peterbilt 15" Air Cleaner Mounting StrapDescription

- Stainless Steel 15" Air Cleaner Mounting Strap for Peterbilt
- Available in OEM Style 1 1/2" Wide Strap or Custom 2 1/2" Wide Strap
- 15" Stainless Steel Air Cleaner Available Separately (Item # 28200)

Item Number	Description	Width	Pack
28210B	15" Air Cleaner Strap	1 1/2"	Bulk = 1 Pc.
28213B	15" Air Cleaner Strap	2 1/2"	Bulk = 1 Pc.

1 1/2" Wide - Item # 28210B**2 1/2" Wide - Item # 28213B****Stainless 15" Peterbilt Air Cleaner Mounting Plate**Description

- Stainless Steel 15" Air Cleaner Mounting Plate for Peterbilt
- 15" Stainless Steel Air Cleaner Mounting Straps Available Separately: 1 1/2" Wide Strap Item # 28210B or 2 1/2" Wide Strap Item # 28213B
- 15" Stainless Steel Air Cleaner Available Separately: Item # 28200

Item Number	Description	Package	Pack
28212	Stainless Mounting Plate	Bulk	1 Pc.

**Stainless Kenworth 15" Air Cleaner Mounting Bracket**Description

- Stainless Steel 15" Air Cleaner Mounting Bracket for Kenworth
- 15" Stainless Steel Air Cleaner Available Separately: Item # 28200

Item Number	Description	Package	Pack
28211B	15" Air Cleaner Bracket	Bulk	1 Pc.

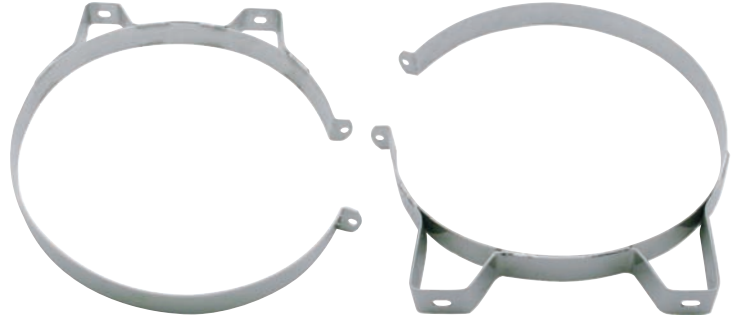
**2007+ Kenworth T660 LED Air Intake**Description

- Chrome Plastic Air Intake with 14 LED 12" Light Bar and 10 LED 9" Light Bar for 2007+ Kenworth T660
- LED Light Bar Available in Amber or Red LED with Colored or Clear Lens
- Please Specify Driver or Passenger Side
- ***Patent Pending***

T660 LED Air Intake - Driver

Item Number	Side	LEDs	Lens	Lights
41530	Driver	10 Amber	Amber	38942B
		14 Amber	Amber	38946B
41532	Driver	10 Red	Red	38943B
		14 Red	Red	38947B
41531	Driver	10 Amber	Clear	38944B
		14 Amber	Clear	38948B
41533	Driver	10 Red	Clear	38945B
		14 Red	Clear	38949B

T660 LED Air Intake - Passenger

Item Number	Side	LEDs	Lens	Lights
41534	Passenger	10 Amber	Amber	38942B
		14 Amber	Amber	38946B
41536	Passenger	10 Red	Red	38943B
		14 Red	Red	38947B
41535	Passenger	10 Amber	Clear	38944B
		14 Amber	Clear	38948B
41537	Passenger	10 Red	Clear	38945B
		14 Red	Clear	38949B

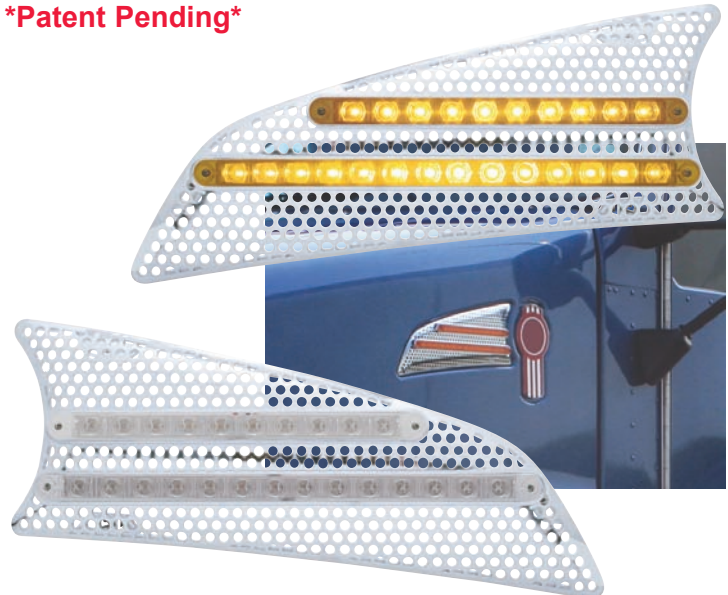
Patent Pending

2007+ Kenworth T660 Air Intake - LED Cutout

Description

- Chrome Plastic Air Intake with 2 LED Light Cutout for 2007+ Kenworth T660
- Available in Driver or Passenger Side
- Fits 2007 and Newer Kenworth T660 Model Only
- ***Patent Pending***

Item Number	Description	Application	Pack
41525	T660 Air Intake	Driver	1 Pc./Card
41526	T660 Air Intake	Passenger	1 Pc./Card

Patent Pending

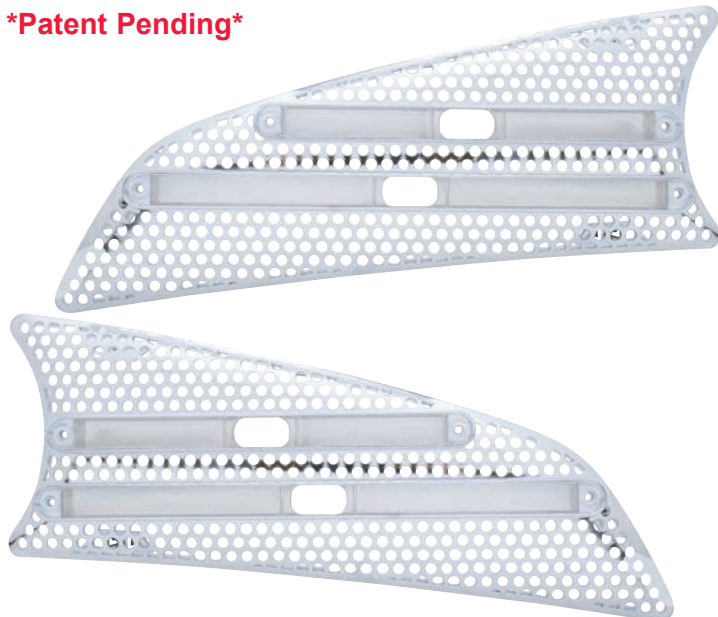

International Air Intake Cover

Description

- Chrome Plastic Air Intake Cover for International
- Fits Over Existing Air Intake Cover

Item Number	Description	Package	Pack
42019	Air Intake Cover	Carded	1 Pc./Card



Recommended Accessories

10 LED 9" S/T/T & P/T/C Light Bar

Description

- 10 LED 9" S/T/T & P/T/C Light Bar
- Available in Red or Amber LEDs with Colored or Clear Lens
- 3 Wires, Approximate Size: 9" L x 5/8" W
- Mounting Holes Approximately 8 1/2" Apart

Item Number	LEDs	Lens	Package	Pack
38942B	10 Amber	Amber	Bulk	1 Pc.
38943B	10 Red	Red	Bulk	1 Pc.
38944B	10 Amber	Clear	Bulk	1 Pc.
38945B	10 Red	Clear	Bulk	1 Pc.



14 LED 12" S/T/T & P/T/C Light Bar

Description

- 14 LED 12" S/T/T & P/T/C Light Bar
- Available in Red or Amber LEDs with Colored or Clear Lens
- 3 Wires, Approximate Size: 12" L x 5/8" W
- Mounting Holes Approximately 11 7/16" Apart

Item Number	LEDs	Lens	Package	Pack
38946B	10 Amber	Amber	Bulk	1 Pc.
38947B	10 Red	Red	Bulk	1 Pc.
38948B	10 Amber	Clear	Bulk	1 Pc.
38949B	10 Red	Clear	Bulk	1 Pc.



Hot Items

Chrome 7" Billet Style "Chopper" Headlights



Razor Visor

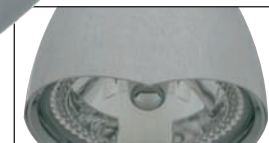

Smooth Visor

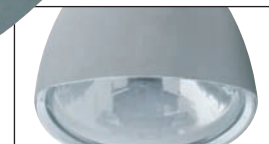

LED Peterbilt Front Air Cleaner Bracket - LED Clearance/Marker Light x 12





Description

- Stainless Steel Peterbilt Front Air Cleaner Bracket with Twelve 17 LED or 19 LED Watermelon Style Clearance/Marker Lights
- 17 LED Clearance/Marker Light Available with Stainless Steel Bezel (Item # 30317), Stainless Steel Bezel with Visor (Item # 30317+10474) or Chrome Plastic Bezel with Visor (Item # 39211)
- Available with 17 LED or 19 LED Clearance/Marker Lights, LED Light Available in 3 Different Styles, 17 LED Light Available in Single or Dual Function
- 19 LED Clearance/Marker Light Available with Chrome Plastic Bezel (Item # 39209B) or with Chrome Plastic Bezel with Visor (Item # 39208B)

17 LED Clearance/Marker Light - Stainless Steel Peterbilt Front Air Cleaner Bracket

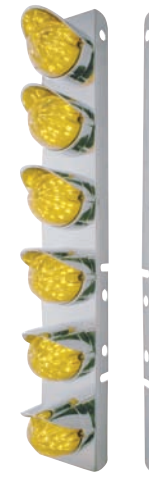
Light Bracket	LED Light				Item Number w/SS Bezel	Item Number w/SS Visor	Item Number w/CR Visor	
	LED Item Number	LEDs	Lens	Function				
		39447B x 12	17 LED	Amber	Single	39636	39838	37386
		39449B x 12	17 LED	Clear	Single	39637	39839	37387
		39320B x 12	17 LED	Amber	Dual	39638	39846	37388
		39322B x 12	17 LED	Clear	Dual	39639	39847	37389
		38152B x 12	17 LED	Amber	Single	31978	39844	37390
		38153B x 12	17 LED	Clear	Single	31979	39845	37391
		39731B x 12	17 LED	Amber	Dual	39796	39848	37392
		39733B x 12	17 LED	Clear	Dual	39797	39849	37393
		39349B x 12	17 LED	Amber	Single	39634	39840	37394
		39351B x 12	17 LED	Clear	Single	39635	39841	37395
		38154B x 12	17 LED	Amber	Single	31980	39842	37396
		38155B x 12	17 LED	Clear	Single	31981	39843	37397

19 LED Clearance/Marker Light - Stainless Steel Peterbilt Front Air Cleaner Bracket

Light Bracket	LED Light				Item Number w/CR Bezel	Item Number w/CR Visor	
	LED Item Number	LEDs	Lens	Style			
		38313B x 12	19 LED	Amber	Watermelon	37984	37699
		38462B x 12	19 LED	Clear	Watermelon	37985	37700
		38312B x 12	19 LED	Amber	Beehive	37986	37701
		38461B x 12	19 LED	Clear	Beehive	37987	37702
		39457B x 12	19 LED	Amber	Reflector	37988	37703
		39458B x 12	19 LED	Clear	Reflector	37989	37704
		39950B x 12	19 LED	Amber	Bullet	37464	37462
		39951B x 12	19 LED	Clear	Bullet	37465	37463

Bezel & Visor

17 LED Light Bezel

Stainless Bezel
30317Stainless Bezel w/ Visor
30317+10474Chrome Plastic Bezel w/ Visor
39211

19 LED Light Bezel

Chrome Plastic Bezel
39209BChrome Plastic Bezel w/ Visor
39208B

LED Product Information

Size/Style Comparison

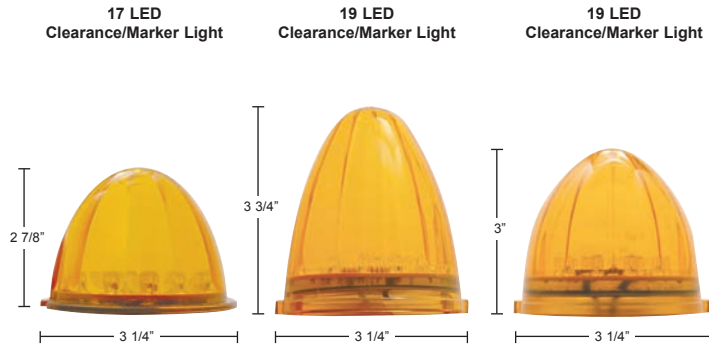

Available Style for 17 LED Clearance/Marker Light



Watermelon Style

- 38152B Amber/Amber
- 38153B Amber/Clear
- 39731B Amber/Amber, Dual Function
- 39733B Amber/Clear, Dual Function



Clear Style w/ Reflector

- 39447B Amber/Amber
- 39449B Amber/Clear
- 39320B Amber/Amber, Dual Function
- 39322B Amber/Clear, Dual Function



Watermelon Style w/ Reflector

- 39349B Amber/Amber
- 39351B Amber/Clear



Beehive Style

- 38154B Amber/Amber
- 38155B Amber/Clear

Available Style for 19 LED Clearance/Marker Light



Reflector Style

- 39457B Amber/Amber
- 39458B Amber/Clear



Watermelon Style

- 38313B Amber/Amber
- 38462B Amber/Clear



Beehive Style

- 38312B Amber/Amber
- 38461B Amber/Clear

Available Style for 19 LED Clearance/Marker Light



Bullet Style

- 39950B Amber/Amber
- 39951B Amber/Clear



Stainless Steel Peterbilt Front Air Cleaner Bracket

Description

- Stainless Steel Peterbilt Front Air Cleaner Bracket with 12 Light Cutouts
- Each Bracket has 6 Light Cutouts, Fits 12 Lights Total

Item Number	Material	Light Hole	Package	Pack
30988-1	Stainless	12	Bulk	1 Pair



Stainless Steel Bracket Only
Item # 30988-1

Shown with LED Lights
Item # 37462

LED Peterbilt Front Air Cleaner Bracket - LED Clearance/Marker Light x 8





Description

- Stainless Steel Peterbilt Front Air Cleaner Bracket with Eight 17 LED or 19 LED Watermelon Style Clearance/Marker Lights
- 17 LED Clearance/Marker Light Available with Stainless Steel Bezel (Item # 30317), Stainless Steel Bezel with Visor (Item # 30317+10474) or Chrome Plastic Bezel with Visor (Item # 39211)
- Available with 17 LED or 19 LED Clearance/Marker Lights, LED Light Available in 3 Different Styles, 17 LED Light Available in Single or Dual Function
- 19 LED Clearance/Marker Light Available with Chrome Plastic Bezel (Item # 39209B) or with Chrome Plastic Bezel with Visor (Item # 39208B)

17 LED Clearance/Marker Light - Stainless Steel Peterbilt Front Air Cleaner Bracket

Light Bracket	LED Light				Item Number w/S.S. Bezel	Item Number w/S.S. Visor	Item Number w/CR Visor	
	LED Item Number	LEDs	Lens	Function				
 Stainless Steel Front Air Cleaner Bracket Item # 30975-1	 17 LED Clear Style w/ Reflector	39447B x 8	17 LED	Amber	Single	39630	39850	37374
		39449B x 8	17 LED	Clear	Single	39631	39851	37375
	 17 LED Dual Function Clear Style w/ Reflector	39320B x 8	17 LED	Amber	Dual	39632	39858	37376
		39322B x 8	17 LED	Clear	Dual	39633	39859	37377
	 17 LED Watermelon Style	38152B x 8	17 LED	Amber	Single	31974	39856	37378
		38153B x 8	17 LED	Clear	Single	31975	39857	37379
	 17 LED Dual Function Watermelon Style	39731B x 8	17 LED	Amber	Dual	39794	39860	37380
		39733B x 8	17 LED	Clear	Dual	39795	39861	37381
	 17 LED Watermelon w/ Reflector	39349B x 8	17 LED	Amber	Single	39628	39852	37382
		39351B x 8	17 LED	Clear	Single	39629	39853	37383
	 17 LED Beehive Light	38154B x 8	17 LED	Amber	Single	31976	39854	37384
		38155B x 8	17 LED	Clear	Single	31977	39855	37385

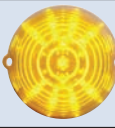
19 LED Clearance/Marker Light - Stainless Steel Peterbilt Front Air Cleaner Bracket

Light Bracket	LED Light				Item Number w/CR Bezel	Item Number w/CR Visor	
	LED Item Number	LEDs	Lens	Style			
 Stainless Steel Front Air Cleaner Bracket Item # 30975-1	 19 LED Watermelon Style	38313B x 8	19 LED	Amber	Watermelon	37990	37705
		38462B x 8	19 LED	Clear	Watermelon	37991	37706
	 19 LED Beehive Style	38312B x 8	19 LED	Amber	Beehive	37992	37707
		38461B x 8	19 LED	Clear	Beehive	37993	37708
	 19 LED Reflector Style	39457B x 8	19 LED	Amber	Reflector	37994	37709
		39458B x 8	19 LED	Clear	Reflector	37995	37710
	 19 LED Bullet Style	39950B x 8	19 LED	Amber	Bullet	37468	37466
		39951B x 8	19 LED	Clear	Bullet	37469	37467

Bezel & Visor

17 LED Light Bezel

Stainless Bezel
30317Stainless Bezel w/ Visor
30317+10474Chrome Plastic Bezel w/ Visor
39211

19 LED Light Bezel

Chrome Plastic Bezel
39209BChrome Plastic Bezel w/ Visor
39208B

LED Product Information

Size/Style Comparison

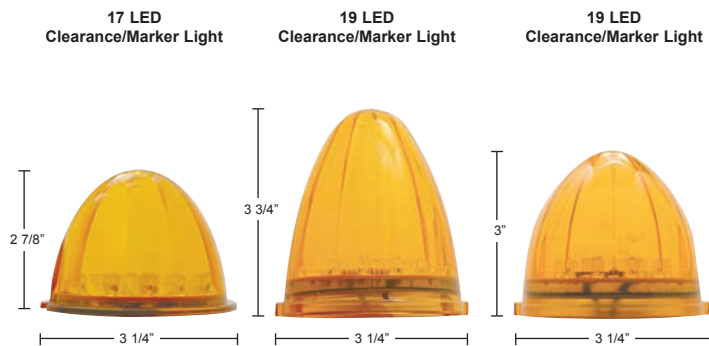

Available Style for 17 LED Clearance/Marker Light



Watermelon Style

- 38152B Amber/Amber
- 38153B Amber/Clear
- 39731B Amber/Amber, Dual Function
- 39733B Amber/Clear, Dual Function



Clear Style w/ Reflector

- 39447B Amber/Amber
- 39449B Amber/Clear
- 39320B Amber/Amber, Dual Function
- 39322B Amber/Clear, Dual Function



Watermelon Style w/ Reflector

- 39349B Amber/Amber
- 39351B Amber/Clear



Beehive Style

- 38154B Amber/Amber
- 38155B Amber/Clear

Available Style for 19 LED Clearance/Marker Light



Reflector Style

- 39457B Amber/Amber
- 39458B Amber/Clear



Watermelon Style

- 38313B Amber/Amber
- 38462B Amber/Clear



Beehive Style

- 38312B Amber/Amber
- 38461B Amber/Clear

Available Style for 19 LED Clearance/Marker Light



Bullet Style

- 39950B Amber/Amber
- 39951B Amber/Clear

Stainless Steel Peterbilt Front Air Cleaner Bracket

Description

- Stainless Steel Peterbilt Front Air Cleaner Bracket with 8 Light Cutouts
- Each Bracket has 4 Light Cutouts, Fits 8 Lights Total

Item Number	Material	Light Hole	Package	Pack
30975-1	Stainless	8	Bulk	1 Pair

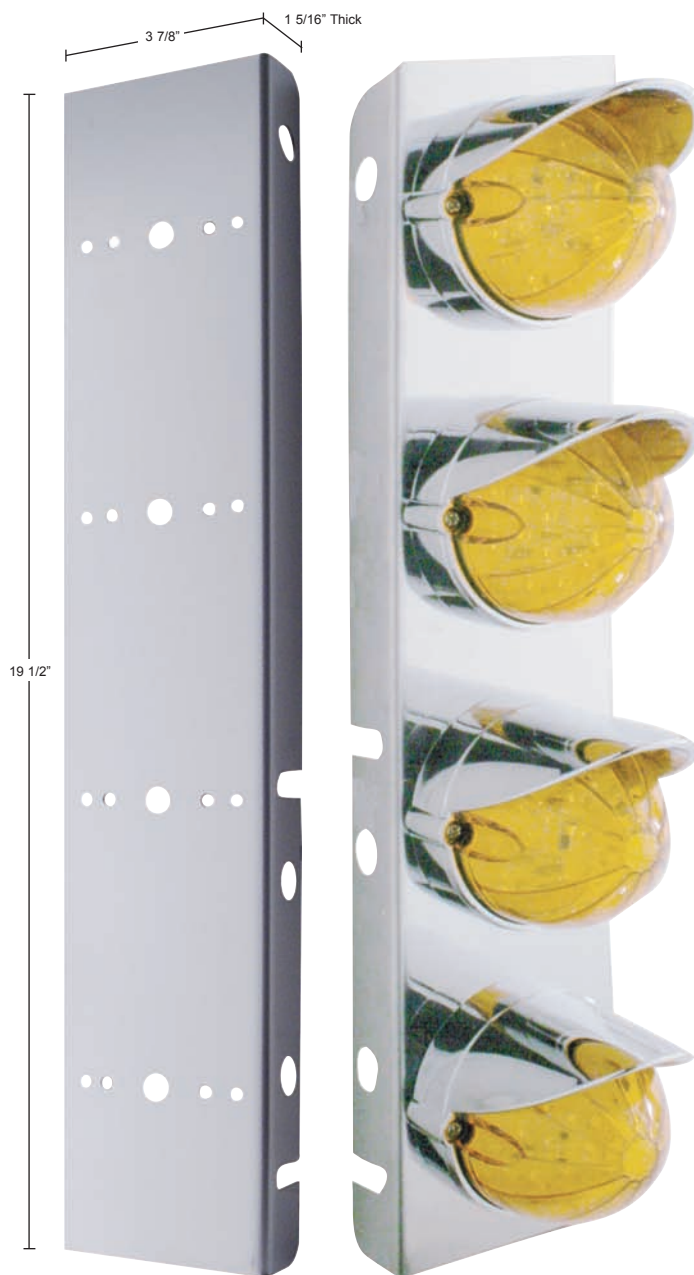

Stainless Steel Bracket Only
Item # 30975-1

Shown with LED Lights
Item # 37466

LED Peterbilt Front Air Cleaner Bracket - 2" LED Clearance/Marker Light x 16

Description

- Stainless Steel Peterbilt Front Air Cleaner Bracket with Sixteen 2" LED Lights
- 2" LED Light Available in 4 Different Styles with Colored or Clear Lens
- Available with Chrome Light Bezel (Item # 10458), Chrome Light Bezel with Visor (Item # 10481), and Rubber Grommet (Item # 31505)

Light Bracket	LED Light			Item Number with Visor	Item Number w/Flat Bezel	Item Number with Grommet	
	LED Item Number	LEDs	Lens				
 <p>Stainless Steel Front Air Cleaner Bracket Item # 30072</p>	 <p>9 LED - Flat</p>	38170B x 16	9 LED	Amber	33600	33700	33800
		38362B x 16	9 LED	Clear	33601	33701	33801
	 <p>9 LED - Reflector</p>	38849B x 16	9 LED	Amber	33602	33702	33802
		38851B x 16	9 LED	Clear	33603	33703	33803
	 <p>9 LED - Low Profile</p>	38409B x 16	9 LED	Amber	33604	33704	33804
		38412B x 16	9 LED	Clear	33605	33705	33805
	 <p>9 LED - Beehive</p>	38168B x 16	9 LED	Amber	33606	33706	33806
		38366B x 16	9 LED	Clear	33607	33707	33807

Peterbilt Front Air Cleaner Light Bracket

Description

- Stainless Steel Peterbilt Front Air Cleaner Light Bracket with Sixteen 2" Light Cutouts
- Each Air Cleaner Bracket has Eight 2" Light Cutouts (Total 16 Light Cutouts)
- Stainless Steel Bracket Only

Item Number	Material	Light Hole	Package	Pack
30072	Stainless	16	Bulk	1 Pair

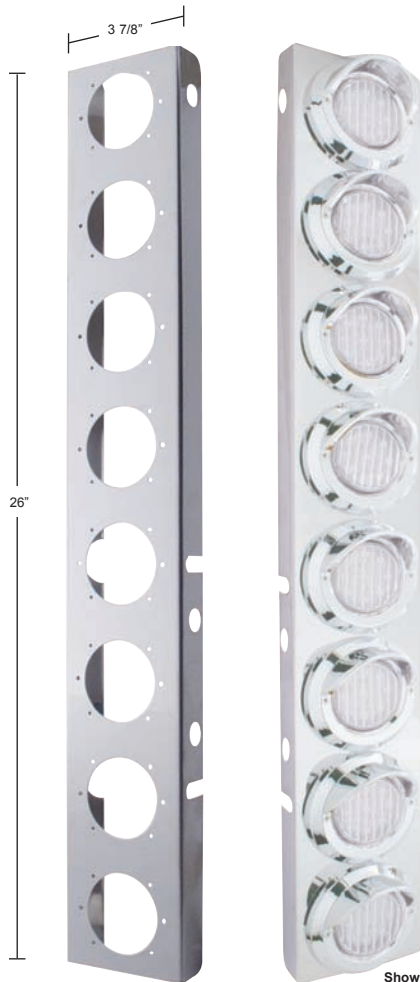

Shown with LED Lights
Item # 33603

Recommended Accessories

2" LED Light



9 LED - Flat
38170B

9 LED - Reflector
38849B

9 LED - Low Profile
38409B

9 LED - Flat
38362B

9 LED - Reflector
38851B

9 LED - Low Profile
38412B

9 LED - Beehive
38168B

9 LED - Beehive
38366B

Bezel / Grommet



2" Bezel w/ Visor
10481





2" Flat Bezel
10458

2" Grommet
31505

LED Peterbilt Front Air Cleaner Bracket - 2" LED Clearance/Marker Light x 12

Description

- Stainless Steel Peterbilt Front Air Cleaner Bracket with Twelve 2" LED Lights
- 2" LED Light Available in 4 Different Styles with Colored or Clear Lens
- Available with Chrome Light Bezel (Item # 10458), Chrome Light Bezel with Visor (Item # 10481) and Rubber Grommet (Item # 31505)

Light Bracket	LED Light			Item Number with Visor	Item Number w/Flat Bezel	Item Number with Grommet	
	LED Item Number	LEDs	Lens				
 <p>Stainless Steel Front Air Cleaner Bracket Item # 30060</p>	 <p>9 LED - Flat</p>	38170B x 12	9 LED	Amber	33608	33708	33808
		38362B x 12	9 LED	Clear	33609	33709	33809
	 <p>9 LED - Reflector</p>	38849B x 12	9 LED	Amber	33610	33710	33810
		38851B x 12	9 LED	Clear	33611	33711	33811
	 <p>9 LED - Low Profile</p>	38409B x 12	9 LED	Amber	33612	33712	33812
		38412B x 12	9 LED	Clear	33613	33713	33813
	 <p>9 LED - Beehive</p>	38168B x 12	9 LED	Amber	33614	33714	33814
		38366B x 12	9 LED	Clear	33615	33715	33815

Peterbilt Front Air Cleaner Light Bracket

Description

- Stainless Steel Peterbilt Front Air Cleaner Light Bracket with Twelve 2" Light Cutouts
- Each Air Cleaner Bracket has Six 2" Light Cutouts (Total 12 Light Cutouts)
- Stainless Steel Bracket Only

Item Number	Material	Light Hole	Package	Pack
30060	Stainless	12	Bulk	1 Pair

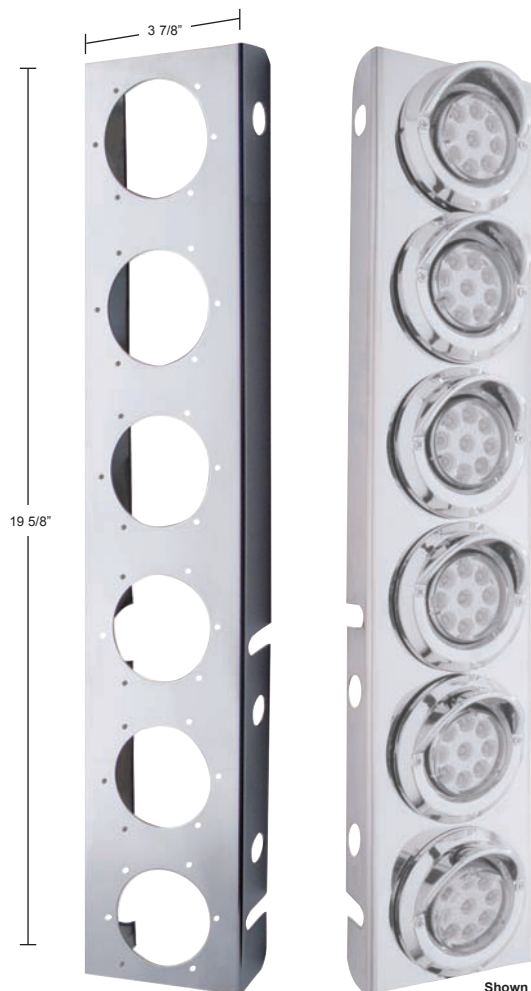

Shown with LED Lights
Item # 33610

Recommended Accessories

2" LED Light



Bezel / Grommet



LED Peterbilt Front Air Cleaner Bracket - 2" LED Clearance/Marker Light x 8

Description

- Stainless Steel Peterbilt Front Air Cleaner Bracket with Eight 2" LED Lights
- 2" LED Light Available in 4 Different Styles with Colored or Clear Lens
- Available with Chrome Light Bezel (Item # 10458), Chrome Light Bezel with Visor (Item # 10481) and Rubber Grommet (Item # 31505)

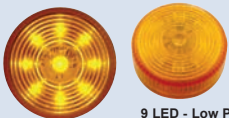
Light Bracket	LED Light			Item Number with Visor	Item Number w/Flat Bezel	Item Number with Grommet	
	LED Item Number	LEDs	Lens				
 <p style="writing-mode: vertical-rl; transform: rotate(180deg);">Stainless Steel Front Air Cleaner Bracket Item # 30260</p>	 <p>9 LED - Flat</p>	38170B x 8	9 LED	Amber	33616	33716	33816
		38362B x 8	9 LED	Clear	33617	33717	33817
	 <p>9 LED - Reflector</p>	38849B x 8	9 LED	Amber	33618	33718	33818
		38851B x 8	9 LED	Clear	33619	33719	33819
	 <p>9 LED - Low Profile</p>	38409B x 8	9 LED	Amber	33620	33720	33820
		38412B x 8	9 LED	Clear	33621	33721	33821
	 <p>9 LED - Beehive</p>	38168B x 8	9 LED	Amber	33622	33722	33822
		38366B x 8	9 LED	Clear	33623	33723	33823

Peterbilt Front Air Cleaner Light Bracket

Description

- Stainless Steel Peterbilt Front Air Cleaner Light Bracket with Eight 2" Light Cutouts
- Each Air Cleaner Bracket has Four 2" Light Cutouts (Total 8 Light Cutouts)
- Stainless Steel Bracket Only

Item Number	Material	Light Hole	Package	Pack
30260	Stainless	8	Bulk	1 Pair



Shown with LED Lights
Item # 33618

Recommended Accessories

2" LED Light



Bezel / Grommet



Recommended Accessories

2 1/2" LED Light



13 LED - Flat
38176B



9 LED - Reflector
39739B



13 LED - Flat
38364B



9 LED - Reflector
39741B



13 LED - Beehive
38178B



13 LED - Beehive
38368B

LED Peterbilt Front Air Cleaner Bracket - 2 1/2" LED Clearance/Marker Light x 14

Description

- Stainless Steel Peterbilt Front Air Cleaner Bracket with Fourteen 2 1/2" LED Lights
- 2 1/2" LED Light Available in 3 Different Styles with Colored or Clear Lens

Light Bracket	LED Light			Item Number with Grommet	
	LED Item Number	LEDs	Lens		
 <p style="writing-mode: vertical-rl; transform: rotate(180deg);">Stainless Steel Air Cleaner Bracket Item # 30065</p>	 <p>13 LED - Flat</p>	38176B x 14	13 LED	Amber	33900
		38364B x 14	13 LED	Clear	33901
	 <p>9 LED - Reflector</p>	39739B x 14	9 LED	Amber	33902
		39741B x 14	9 LED	Clear	33903
	 <p>13 LED - Beehive</p>	38178B x 14	13 LED	Amber	33904
		38368B x 14	13 LED	Clear	33905

LED Peterbilt Front Air Cleaner Bracket - 2 1/2" LED Clearance/Marker Light x 10

Description

- Stainless Steel Peterbilt Front Air Cleaner Bracket with Ten 2 1/2" LED Lights
- 2 1/2" LED Light Available in 3 Different Styles with Colored or Clear Lens

Light Bracket	LED Light			Item Number with Grommet	
	LED Item Number	LEDs	Lens		
 <p style="writing-mode: vertical-rl; transform: rotate(180deg);">Stainless Steel Air Cleaner Bracket Item # 30057</p>	 <p>13 LED - Flat</p>	38176B x 10	13 LED	Amber	33906
		38364B x 10	13 LED	Clear	33907
	 <p>9 LED - Reflector</p>	39739B x 10	9 LED	Amber	33908
		39741B x 10	9 LED	Clear	33909
	 <p>13 LED - Beehive</p>	38178B x 10	13 LED	Amber	33910
		38368B x 10	13 LED	Clear	33911

Peterbilt Front Air Cleaner Light Bracket

Description

- Stainless Steel Peterbilt Front Air Cleaner Light Bracket with Fourteen 2 1/2" Light Cutouts
- Each Bracket has Seven 2 1/2" Light Cutouts (Total 14 Light Cutouts)

Item Number	Material	Light Hole	Package	Pack
30065	Stainless	14	Bulk	1 Pair

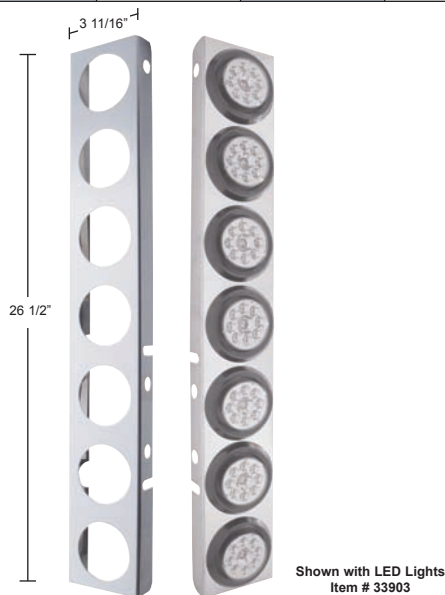

Peterbilt Front Air Cleaner Light Bracket

Description

- Stainless Steel Peterbilt Air Cleaner Light Bracket with Ten 2 1/2" Light Cutouts
- Each Bracket has Five 2 1/2" Light Cutouts (Total 10 Light Cutouts)
- Fits 10 Lights Total

Item Number	Material	Light Hole	Package	Pack
30057	Stainless	10	Bulk	1 Pair

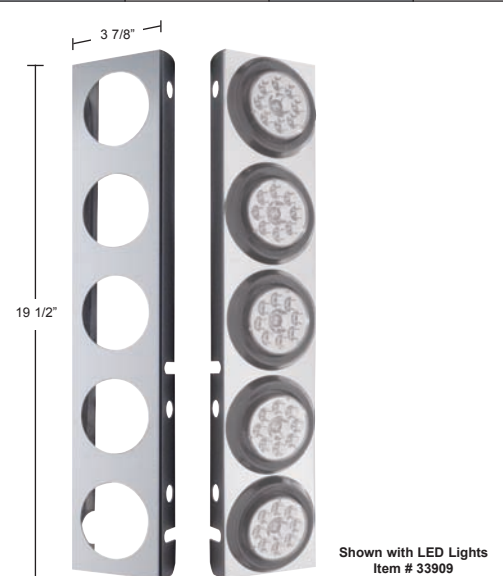



LED Peterbilt Front Air Cleaner Bracket - Medium Watermelon LED Light



Description

- Stainless Steel Peterbilt Front Air Cleaner Bracket with 11 LED Medium Watermelon Lights
- Includes Stainless Steel Bezel (Item # 30472-1) or Stainless Steel Bezel with Visor (Item # 10474)
- Stainless Steel Air Cleaner Light Bracket Available Separately: tem # 30060 (12 Light Cutouts), Item # 30260 (8 Light Cutouts)

LED Medium Watermelon Light x 12

LED Light				Item Number	Item Number
LED Item Number		LEDs	Lens	with Visor	w/ S.S. Bezel
 	38427B x 12	11 LED	Amber	33914	33920
	38429B x 12	11 LED	Clear	33915	33921

LED Medium Watermelon Light x 8

LED Light				Item Number	Item Number
LED Item Number		LEDs	Lens	with Visor	w/ S.S. Bezel
 	38427B x 8	11 LED	Amber	33916	33922
	38429B x 8	11 LED	Clear	33917	33923

Peterbilt Front Air Cleaner Light Bracket

Description

- Stainless Steel Peterbilt Front Air Cleaner Light Bracket with Medium Watermelon Light Cutout
- Available with 16 Light Cutout, 12 Light Cutout, or 8 Light Cutout

Item Number	Description	Package	Pack
30060	Light Bracket w/ 12 Cutout	Bulk	1 Pair
30260	Light Bracket w/ 8 Cutout	Bulk	1 Pair

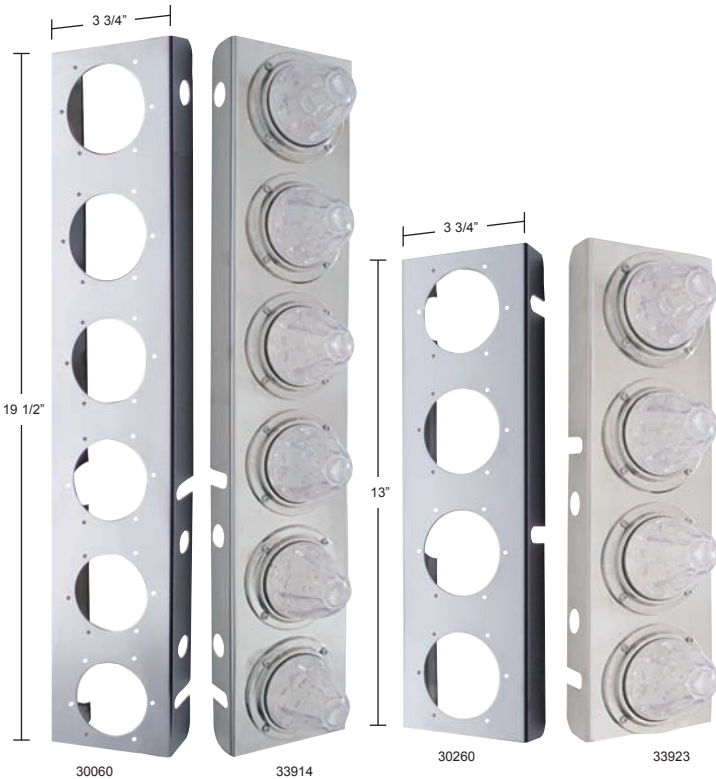

Recommended Accessories

11 LED Medium Watermelon Light



38427 Lit



38427



38429 Lit



38429

Stainless Bezel & Visor



38427



38429



33914



33923

LED Kenworth Front Air Cleaner Bracket - 2" LED Clearance/Marker Light x 14

Description

- Stainless Steel Kenworth Front Air Cleaner Bracket with Fourteen 2" LED Lights
- 2" LED Light Available in 4 Different Styles with Colored or Clear Lens
- Available with Chrome Light Bezel (Item # 10458), Chrome Light Bezel with Visor (Item # 10481) and Rubber Grommet (Item # 31505)

Light Bracket	LED Light			Item Number with Visor	Item Number w/Flat Bezel	Item Number with Grommet	
	LED Item Number	LEDs	Lens				
 <p>Stainless Steel Front Air Cleaner Bracket Item # 31465</p>	 <p>9 LED - Flat</p>	38170B x 14	9 LED	Amber	33624	33724	33824
		38362B x 14	9 LED	Clear	33625	33725	33825
	 <p>9 LED - Reflector</p>	38849B x 14	9 LED	Amber	33626	33726	33826
		38851B x 14	9 LED	Clear	33627	33727	33827
	 <p>9 LED - Low Profile</p>	38409B x 14	9 LED	Amber	33628	33728	33828
		38412B x 14	9 LED	Clear	33629	33729	33829
	 <p>9 LED - Beehive</p>	38168B x 14	9 LED	Amber	33630	33730	33830
		38366B x 14	9 LED	Clear	33631	33731	33831

Kenworth Front Air Cleaner Light Bracket

Description

- Stainless Steel Kenworth Front Air Cleaner Light Bracket with Fourteen 2" Light Cutouts
- Each Air Cleaner Bracket has Seven 2" Light Cutouts (Total 14 Light Cutouts)
- Stainless Steel Bracket Only

Item Number	Material	Light Hole	Package	Pack
31465	Stainless	14	Bulk	1 Pair

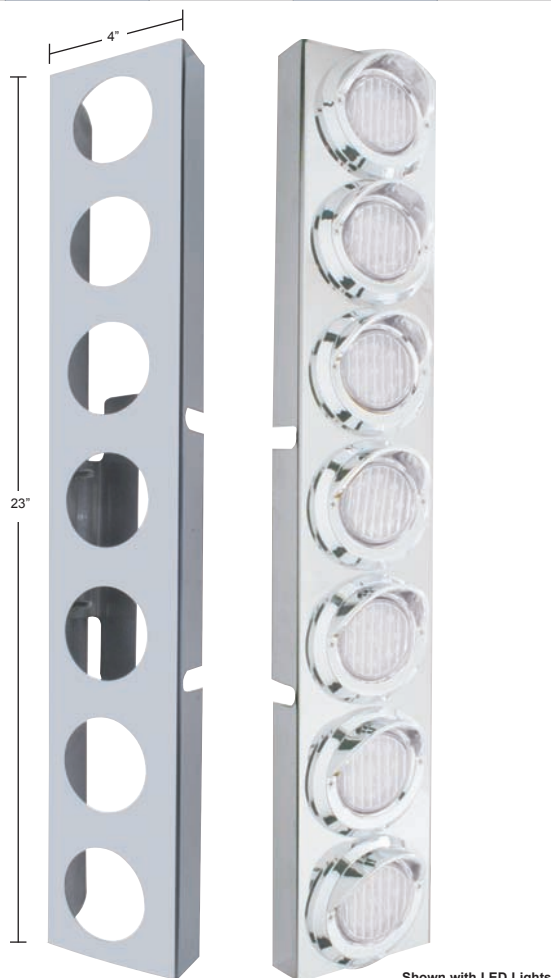

Recommended Accessories

2" LED Light





Bezel / Grommet



LED Kenworth Front Air Cleaner Bracket - 2" LED Clearance/Marker Light x 10

Description

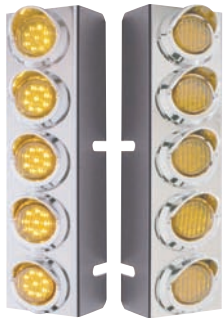
- Stainless Steel Kenworth Front Air Cleaner Bracket with Ten 2" LED Lights
- 2" LED Light Available with 4 Different Styles with Colored or Clear Lens
- Available with Chrome Light Bezel (Item # 10458), Chrome Light Bezel with Visor (Item # 10481) and Rubber Grommet (Item # 31505)

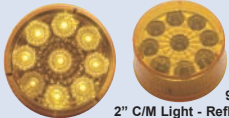
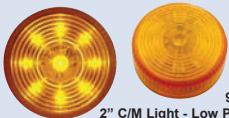
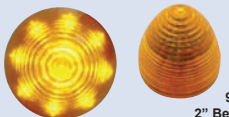
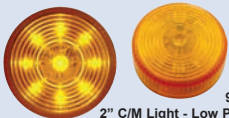
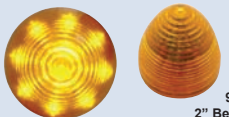
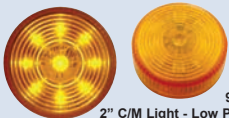
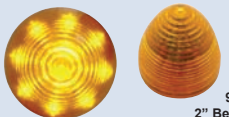
Light Bar	LED Light			Item Number with Visor	Item Number w/Flat Bezel	Item Number with Grommet	
	LED Item Number	LEDs	Lens				
 <p style="writing-mode: vertical-rl; transform: rotate(180deg);">Stainless Steel Front Air Cleaner Bracket Item # 30183-1</p>	 <p>9 LED 2" Clearance/Marker Light</p>	38170B x 10	9 LED	Amber	34568	34668	34768
	 <p>9 LED 2" C/M Light - Reflector</p>	38362B x 10	9 LED	Clear	34569	34669	34769
	 <p>9 LED 2" C/M Light - Low Profile</p>	38849B x 10	9 LED	Amber	34570	34670	34770
	 <p>9 LED 2" Beehive</p>	38851B x 10	9 LED	Clear	34571	34671	34771
	 <p>9 LED 2" Clearance/Marker Light</p>	38409B x 10	9 LED	Amber	34572	34672	34772
	 <p>9 LED 2" C/M Light - Low Profile</p>	38412B x 10	9 LED	Clear	34573	34673	34773
	 <p>9 LED 2" Beehive</p>	38168B x 10	9 LED	Amber	34574	34674	34774
	 <p>9 LED 2" Beehive</p>	38366B x 10	9 LED	Clear	34575	34675	34775

Kenworth Front Air Cleaner Light Bracket

Description

- Stainless Steel Kenworth Front Air Cleaner Light Bracket with Ten 2" Light Cutouts
- Each Air Cleaner Bracket has Five 2" Light Cutouts (Total 10 Light Cutouts)
- Stainless Steel Bracket Only

Item Number	Material	Light Hole	Package	Pack
30183-1	Stainless	10	Bulk	1 Pair

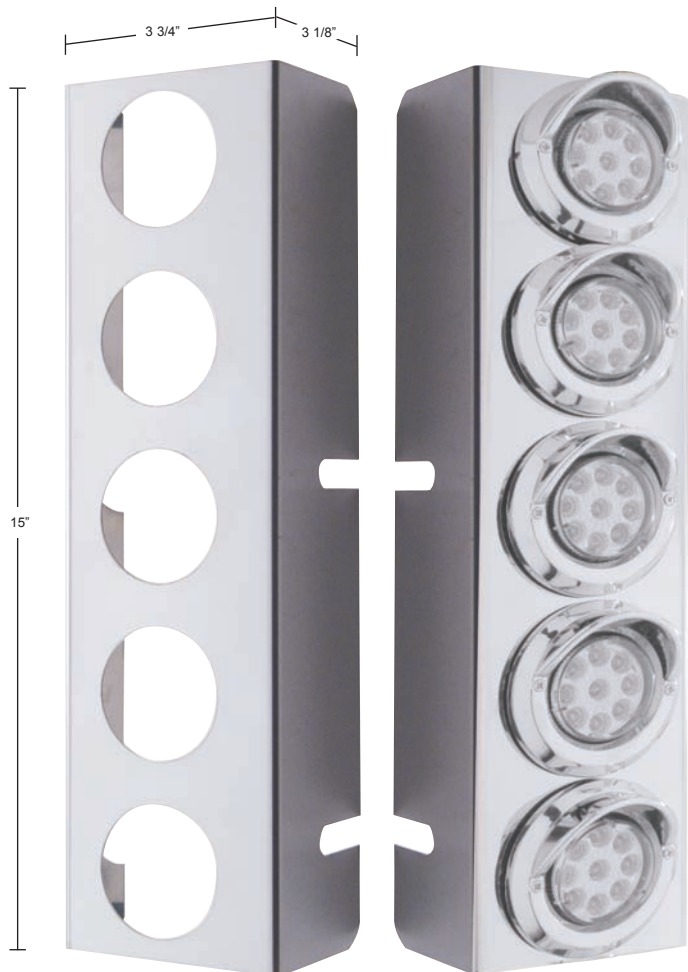

Shown with LED Lights
Item # 00000

Recommended Accessories

2" LED Light



Bezel / Grommet



LED Kenworth Front Air Cleaner Bracket - Medium Watermelon LED Light

Description

- Stainless Steel Kenworth Front Air Cleaner Bracket with 11 LED Medium Watermelon Lights
- Includes Stainless Steel Bezel (Item # 30472-1) or Stainless Steel Bezel with Visor (Item # 10474)
- Stainless Steel Air Cleaner Light Bracket Available Separately: Item # 31465 (14 Light Cutouts), 30183-1 (10 Light Cutouts)

LED Medium Watermelon Light x 14

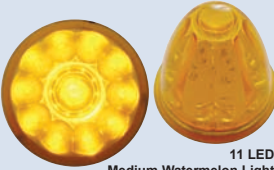
LED Light			Item Number with Visor	Item Number w/ SS Bezel	
LED Item Number	LEDs	Lens			
 11 LED Medium Watermelon Light	38427B x 14	11 LED	Amber	37366	37367
	38429B x 14	11 LED	Clear	37368	37369

LED Medium Watermelon Light x 10

LED Light			Item Number with Visor	Item Number w/ SS Bezel	
LED Item Number	LEDs	Lens			
 11 LED Medium Watermelon Light	38427B x 10	11 LED	Amber	37370	37371
	38429B x 10	11 LED	Clear	37372	37373

Recommended Accessories

11 LED Medium Watermelon Light



38427



38429

Stainless Bezel & Visor



38427



38429

Kenworth Front Air Cleaner Light Bracket

Description

- Stainless Steel Kenworth Front Air Cleaner Light Bracket with Fourteen or Ten 2" Light Cutouts
- Each Air Cleaner Bracket has Seven or Five 2" Light Cutouts
- Stainless Steel Bracket Only

Item Number	Material	Light Hole	Package	Pack
31465	Stainless	14	Bulk	1 Pair
30183-1	Stainless	10	Bulk	1 Pair

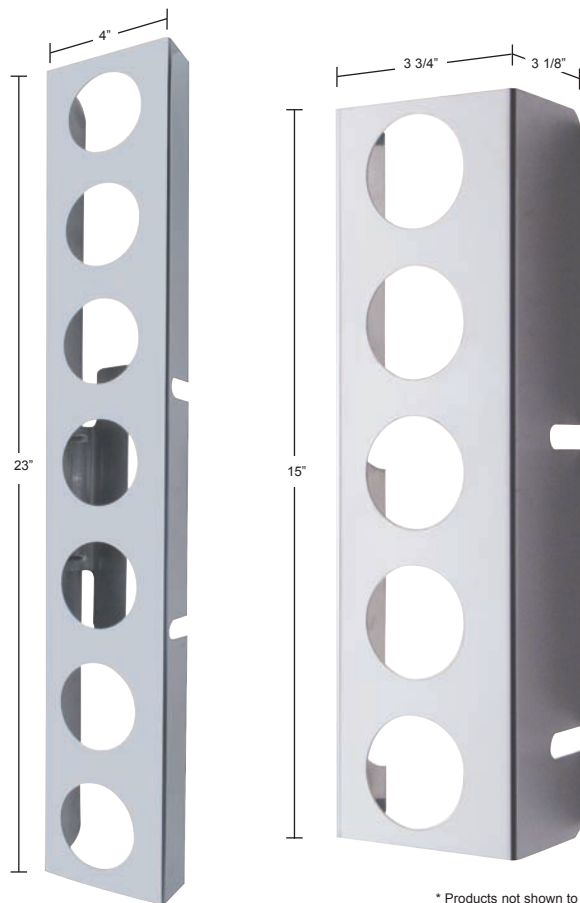

* Products not shown to scale



37366





37370

LED Freightliner Front Air Cleaner Bracket - 2" LED Clearance/Marker Light x 12

Description

- Stainless Steel Freightliner Front Air Cleaner Bracket with Twelve 2" LED Lights
- 2" LED Light Available in 4 Different Styles with Colored or Clear Lens
- Available with Chrome Light Bezel (Item # 10458), Chrome Light Bezel with Visor (Item # 10481), and Rubber Grommet (Item # 31505)

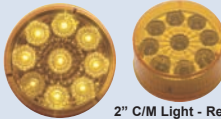
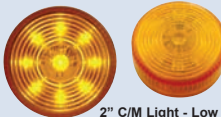
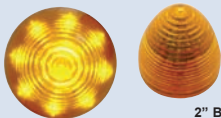
Light Bar	LED Light			Item Number with Visor	Item Number w/Flat Bezel	Item Number with Grommet	
	LED Item Number	LEDs	Lens				
 <p style="writing-mode: vertical-rl; transform: rotate(180deg);">Stainless Steel Front Air Cleaner Bracket Item # 33051</p>	 <p>9 LED 2" Clearance/Marker Light</p>	38170B x 12	9 LED	Amber	33055	37322	33054
		38362B x 12	9 LED	Clear	34576	34676	34776
	 <p>9 LED 2" C/M Light - Reflector</p>	38849B x 12	9 LED	Amber	34577	34677	34777
		38851B x 12	9 LED	Clear	34578	34678	34778
	 <p>9 LED 2" C/M Light - Low Profile</p>	38409B x 12	9 LED	Amber	34579	34679	34779
		38412B x 12	9 LED	Clear	34580	34680	34780
	 <p>9 LED 2" Beehive</p>	38168B x 12	9 LED	Amber	33057	37323	33056
		38366B x 12	9 LED	Clear	34581	34681	34781

Freightliner Front Air Cleaner Light Bracket

Description

- Stainless Steel Freightliner Front Air Cleaner Bracket with Twelve 2" Light Cutouts
- Each Air Cleaner Bracket has Six 2" Light Cutouts (Total 12 Light Cutouts)
- Stainless Steel Bracket Only

Item Number	Material	Light Hole	Package	Pack
33051	Stainless	12	Bulk	1 Pair

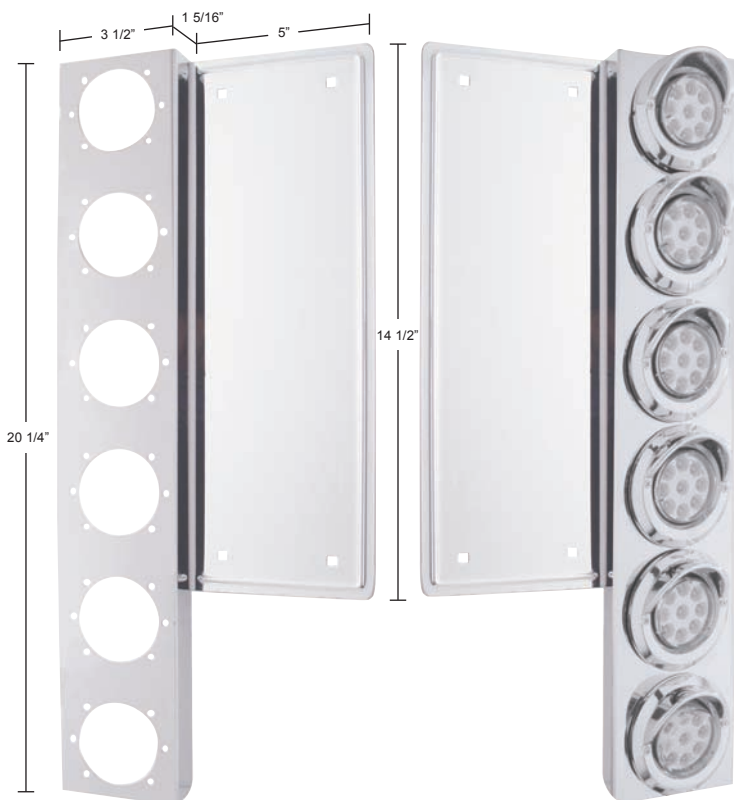

Recommended Accessories

2" LED Light















Bezel / Grommet



LED Freightliner Front Air Cleaner Bracket - LED Clearance/Marker Light x 6

Description

- Stainless Steel Freightliner Front Air Cleaner Bracket with 6 Clearance/Marker Lights
- LED Clearance/Marker Light Available with 6 Different Styles
- Stainless Steel Front Air Cleaner Bracket Available Separately (Item # 33071)

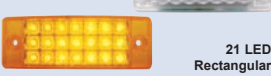
Bracket	LED Light					Item Number
	LED Item Number	Style	LEDs	Lens		
 <p style="writing-mode: vertical-rl; transform: rotate(180deg);">Stainless Steel Front Air Cleaner Bracket Item # 33071</p>	 16 LED Phantom I 38284B x 6	Phantom I	16 Amber	Amber	33078	
	 16 LED Phantom I 38286B x 6	Phantom I	16 Amber	Clear	33079	
	 12 LED Phantom I 38230B x 6	Phantom I	12 Amber	Amber	33076	
	 12 LED Phantom I 38234B x 6	Phantom I	12 Amber	Clear	33077	
	 4 LED Reflector 39398B x 6	Reflector	4 Amber	Amber	37358	
	 4 LED Reflector 39400B x 6	Reflector	4 Amber	Clear	37359	
	 10 LED Reflector 39451B x 6	Reflector	10 Amber	Amber	37360	
	 10 LED Reflector 39453B x 6	Reflector	10 Amber	Clear	37361	
	 12 LED Rectangular 38134B x 6	Rectangular	12 Amber	Amber	37362	
	 12 LED Rectangular 38218B x 6	Rectangular	12 Amber	Clear	37363	
	 21 LED Rectangular 38256B x 6	Rectangular	21 Amber	Amber	37364	
	 21 LED Rectangular 38296B x 6	Rectangular	21 Amber	Clear	37365	

Freightliner Air Cleaner Light Bracket - Universal Cutout

Description

- Stainless Steel Freightliner Front Air Cleaner Light Bracket with 6 Universal Light Cutouts
- Each Air Cleaner Bracket has Three Universal Light Cutouts (Total 6 Cutouts)
- Stainless Steel Bracket Only

Item Number	Material	Light Hole	Package	Pack
33071	Stainless	6	Bulk	1 Pair

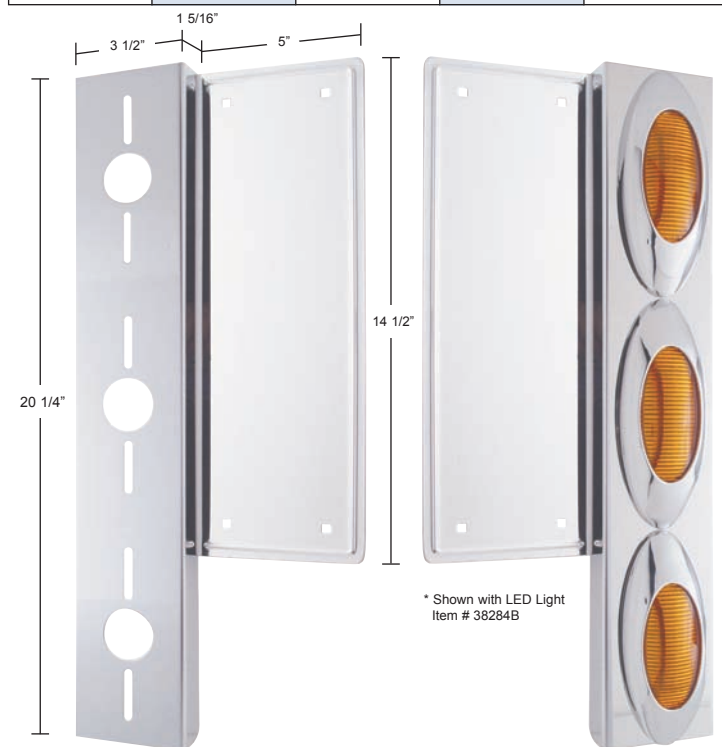

Recommended Accessories



LED Freightliner Front Air Cleaner Bracket - "Phantom II" LED Light x 10

Description

- Stainless Steel Freightliner Front Air Cleaner Bracket with Ten "Phantom II" LED Light
- "Phantom II" LED Light Available with Amber Lens (Item # 38220B) or Clear Lens (Item # 38222B)
- Stainless Front Air Cleaner Bracket Available Separately (Item # 33073)

Item Number	LED Light			
	LED Item Number	LEDs	Lens	
33074	 38220B x 10	5 LED	Amber	
33075	 38222B x 10	5 LED	Clear	



LED Freightliner Front Air Cleaner Bracket - Medium Watermelon LED Light x 12

Description

- Stainless Steel Freightliner Air Cleaner Bracket with 11 LED Medium Watermelon Lights
- Includes Stainless Steel Bezel (Item # 30472-1) or Stainless Steel Bezel with Visor (Item # 10474)
- Stainless Steel Air Cleaner Light Bracket Available Separately (Item # 33051)

Item Number with Visor	Item Number w/ SS Bezel	LED Light		
		Item Number	LEDs	Lens
37354	37355	38427B x 12	11 LED	Amber
37356	37357	38429B x 12	11 LED	Clear



Freightliner Front Air Cleaner Bracket - "Phantom II" Cutout

Description

- Stainless Steel Freightliner Front Air Cleaner Light Bracket with Ten "Phantom II" Light Cutout
- Each Air Cleaner Bracket has Five 2" Light Cutouts (Total 10 Light Cutouts)
- Stainless Steel Bracket Only

Item Number	Material	Light Hole	Package	Pack
33073	Stainless	10	Bulk	1 Pair



Freightliner Front Air Cleaner Light Bracket - Medium Watermelon Cutout

Description

- Stainless Steel Freightliner Front Air Cleaner Light Bracket with Medium Watermelon Light Cutout
- Each Air Cleaner Bracket has Six Medium Watermelon Light Cutouts (Total 12 Light Cutouts)

Item Number	Material	Light Hole	Package	Pack
33051	Stainless	12	Bulk	1 Pair



Incandescent Peterbilt Front Air Cleaner Bracket - Glass Watermelon Light

Description

- Stainless Steel Peterbilt Front Air Cleaner Bracket with Glass Watermelon Light
- Available with Stainless Steel Bezel (Item # 30304) or Stainless Steel Bezel with Visor (Item # 10474)
- Stainless Steel Air Cleaner Bracket Available Separately: Item # 30988-1 (12 Light Cutouts), Item # 30975-1 (8 Light Cutouts)

Glass Watermelon Light x 12

Item Number w/S.S. Bezel	Item Number w/S.S. Visor	Incandescent Glass Light		
		Style	Color	Item Number
30994	30995		Amber	30309 x 12
30992	30993		Dark Amber	30522 x 12
30990	30991		Amber	30301 x 12
30988	30989		Dark Amber	30521 x 12
30998	30999		Amber	30312 x 12
30996	30997		Dark Amber	30523 x 12

Glass Watermelon Light x 8

Item Number w/S.S. Bezel	Item Number w/S.S. Visor	Incandescent Glass Light		
		Style	Color	Item Number
30981	30982		Amber	30309 x 8
30979	30980		Dark Amber	30522 x 8
30977	30978		Amber	30301 x 8
30975	30976		Dark Amber	30521 x 8
30985	30986		Amber	30312 x 8
30983	30984		Dark Amber	30523 x 8



Incandescent Peterbilt Front Air Cleaner Bracket - 2" Incandescent Light

Description

- Stainless Steel Peterbilt Front Air Cleaner Bracket with 2" Incandescent Lights
- Available with Chrome Light Bezel (Item # 10458), Chrome Light Bezel with Visor (Item # 10481) and Rubber Grommet (Item # 31505)
- Stainless Steel Air Cleaner Bracket Available Separately: # 30072 (16 Light Cutouts)/Item # 30060 (12 Light Cutouts), Item # 30260 (8 Light Cutouts)

2" Incandescent Light x 16

Item Number with Visor	Item Number w/ Flat Bezel	Item Number w/ Grommet	Incandescent Light	
			Style	Item Number
30775	30776	30073	Flat	30191 x 16
30774	30777	30070	Beehive	30913 x 16

2" Incandescent Light x 12

Item Number with Visor	Item Number w/ Flat Bezel	Item Number w/ Grommet	Incandescent Light	
			Style	Item Number
30773	30778	30063	Flat	30191 x 12
30772	30779	30061	Beehive	30913 x 12

2" Incandescent Light x 8

Item Number with Visor	Item Number w/ Flat Bezel	Item Number w/ Grommet	Incandescent Light	
			Style	Item Number
30771	30788	30261	Flat	30191 x 8
30781	30789	30264	Beehive	30913 x 8



Recommended Accessories

2" Incandescent Light

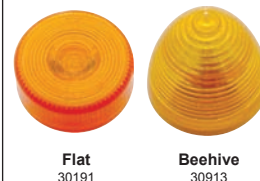

Bezel / Grommet

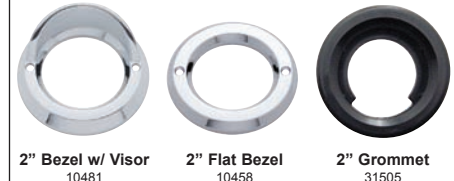

Incandescent Peterbilt Air Cleaner Bracket - 2 1/2" Incandescent Light

Description

- Stainless Steel Peterbilt Front Air Cleaner Bracket with 2 1/2" Incandescent Lights
- Stainless Steel Air Cleaner Light Bracket Available Separately: Item # 30065 (14 Light Cutouts), Item # 30057 (10 Light Cutouts)

2 1/2" Incandescent Light x 14

Item Number	Incandescent Light		Bezel	
	Style	Item Number	Style	Item Number
31630		31061 x 14	Visor	10482
31631		31061 x 14	Flat	10459
31632		31061 x 14	Grommet	31504
31633		30169 x 14	Visor	10482
31634		30169 x 14	Flat	10459
30066		30169 x 14	Grommet	31504

2 1/2" Incandescent Light x 10

Item Number	Incandescent Light		Bezel	
	Style	Item Number	Style	Item Number
31635		31061 x 10	Visor	10482
31636		31061 x 10	Flat	10459
31637		31061 x 10	Grommet	31504
31638		30169 x 10	Visor	10482
31639		30169 x 10	Flat	10459
30058		30169 x 10	Grommet	31504



Incandescent Peterbilt Front Air Cleaner Bracket - Medium Glass Watermelon Light

Description

- Stainless Steel Peterbilt Front Air Cleaner Bracket with Medium Glass Watermelon Lights
- Includes Stainless Steel Bezel (Item # 30472-10), Available with or without Stainless Steel Visor (Item # 10474)
- Stainless Steel Air Cleaner Light Bracket Available Separately: Item # 30060 (12 Light Cutouts), Item # 30260 (8 Light Cutouts)

Medium Glass Watermelon Light x 12

Item Number	Incandescent Glass Light		Bezel Number	Visor Number
	Style	Item Number		
31640		20489 x 12	30472-10 x 12	No Visor
31641		20489 x 12	30472-10 x 12	10474 x 12

Medium Glass Watermelon Light x 8

Item Number	Incandescent Glass Light		Bezel Number	Visor Number
	Style	Item Number		
31642		20489 x 8	30472-10 x 8	No Visor
31643		20489 x 8	30472-10 x 8	10474 x 8



Incandescent Kenworth Front Air Cleaner Bracket - 2" Incandescent Light

Description

- Stainless Kenworth Front Air Cleaner Bracket with 2" Incandescent Lights
- Available with Chrome Light Bezel (Item # 10458), Chrome Light Bezel with Visor (Item # 10481) and Rubber Grommet (Item # 31505)
- Stainless Steel Air Cleaner Light Bracket Available Separately: Item # 30183-1 (10 Light Cutouts), Item # 31465 (14 Light Cutouts)

2" Incandescent Light x 14

Item Number with Visor	Item Number w/ Flat Bezel	Item Number w/ Grommet	Incandescent Light	
			Style	Item Number
34582	34682	34782	Flat	30191 x 14
34583	34683	34783	Beehive	30913 x 14

2" Incandescent Light x 10

Item Number with Visor	Item Number w/ Flat Bezel	Item Number w/ Grommet	Incandescent Light	
			Style	Item Number
34584	34684	34784	Flat	30191 x 10
34585	34685	34785	Beehive	30913 x 10



* Products not shown to scale

Recommended Accessories

2" Incandescent Light



Flat 30191
Beehive 30913

Bezel / Grommet





Bezel w/ Visor 10481
Flat Bezel 10458
Grommet 31505

Incandescent Peterbilt Front Air Cleaner Bracket - Medium Glass Watermelon Light



Description

- Stainless Steel Kenworth Front Air Cleaner Bracket with Medium Glass Watermelon Lights
- Includes Stainless Steel Bezel (Item # 30472-10), Available with or without Stainless Steel Visor (Item # 10474)
- Stainless Steel Air Cleaner Light Bracket Available Separately: Item # 30183-1 (10 Light Cutouts), Item # 31465 (14 Light Cutouts)

Medium Glass Watermelon Light x 14

Item Number	Incandescent Glass Light		Bezel Number	Visor Number
	Style	Item Number		
31478		20489 x 14	30472-10 x 14	No Visor
31479		20489 x 14	30472-10 x 14	10474 x 14

Medium Glass Watermelon Light x 10

Item Number	Incandescent Glass Light		Bezel Number	Visor Number
	Style	Item Number		
31480		20489 x 10	30472-10 x 10	No Visor
31481		20489 x 10	30472-10 x 10	10474 x 10



* Products not shown to scale

Recommended Accessories

Watermelon Light



Medium Glass Watermelon 20489

Bezel / Visor



Bezel 30472-1
Visor 10474

Incandescent Freightliner Front Air Cleaner Bracket - 2" Incandescent Light

Description

- Stainless Steel Freightliner Front Air Cleaner Bracket with 2" Incandescent Lights
- Available with Chrome Light Bezel (Item # 10458), Chrome Light Bezel with Visor (Item # 10481) and Rubber Grommet (Item # 31505)
- Stainless Steel Air Cleaner Light Bracket Available Separately: Item # 33051 (12 Light Cutouts)



Item Number with Visor	Item Number w/ Flat Bezel	Item Number w/ Grommet	Incandescent Light	
			Style	Item Number
34586	34686	34786	Flat	30191 x 12
34587	34687	34787	Beehive	30913 x 12



Incandescent Freightliner Front Air Cleaner Bracket - Medium Glass Watermelon Light

Description

- Stainless Steel Freightliner Front Air Cleaner Kit with Medium Glass Watermelon Lights
- Includes Stainless Steel Bezel (Item # 30472-10) with or without Stainless Steel Visor (Item # 10474)
- Stainless Steel Air Cleaner Light Bracket Available Separately: Item # 33051 (12 Light Cutouts)

Item Number	Incandescent Glass Light		Bezel Number	Visor Number
	Style	Item Number		
31482		20489 x 12	30472-10 x 12	No Visor
31483		20489 x 12	30472-10 x 12	10474 x 12



The Baddest Shift Knob on the Market



LED Peterbilt Rear Air Cleaner Bracket - 2" LED Clearance/Marker Light

Description

- Stainless Steel Peterbilt Rear Air Cleaner Bracket with 2" LED Lights, Available with 16 or 12 LED Lights
- 2" LED Light Available in 4 Different Styles with Colored or Clear Lens
- Stainless Steel Air Cleaner Light Bracket Available Separately: Item # 31467 (16 Light Cutouts), Item # 31460 (12 Light Cutouts)
- Available with Chrome Light Bezel (Item # 10458) and Rubber Grommet (Item # 31505)

2" LED Clearance/Marker Light x 16

Light Bar	LED Light			Item Number w/CR Bezel	Item Number with Grommet	
	LED Item Number	LEDs	Lens			
 Stainless Rear Air Cleaner Bracket Item # 31467	 9 LED 2" Clearance/Marker Light	38171B x 16	9 LED	Red	37330	37331
		38363B x 16	9 LED	Clear	37332	37333
	 9 LED 2" C/M Light - Reflector	38850B x 16	9 LED	Red	37334	37335
		38852B x 16	9 LED	Clear	37336	37337
	 9 LED 2" C/M Light - Low Profile	38411B x 16	9 LED	Red	37338	37339
		38413B x 16	9 LED	Clear	37340	37341

2" LED Clearance/Marker Light x 12

Light Bar	LED Light			Item Number w/CR Bezel	Item Number with Grommet	
	LED Item Number	LEDs	Lens			
 Stainless Rear Air Cleaner Bracket Item # 31460	 9 LED 2" Clearance/Marker Light	38171B x 12	9 LED	Red	37342	37343
		38363B x 12	9 LED	Clear	37344	37345
	 9 LED 2" C/M Light - Reflector	38850B x 12	9 LED	Red	37346	37347
		38852B x 12	9 LED	Clear	37348	37349
	 9 LED 2" C/M Light - Low Profile	38411B x 12	9 LED	Red	37350	37351
		38413B x 12	9 LED	Clear	37352	37353

Peterbilt Rear Air Cleaner Light Bracket

Description

- Stainless Steel Peterbilt Rear Air Cleaner Light Bracket with 2" Light Cutouts
- Air Cleaner Bracket Available with Eight 2" Light Cutouts (Total 16 Cutouts) or Six 2" Light Cutouts (Total 12 Cutouts)
- Stainless Steel Bracket Only

Item Number	Material	Light Hole	Package	Pack
31467	Stainless	16	Bulk	1 Pair
31460	Stainless	12	Bulk	1 Pair

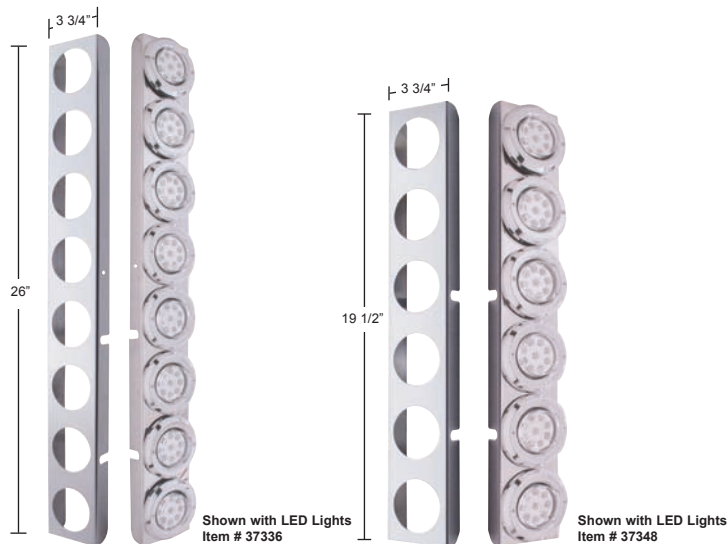

Recommended Accessories

2" LED Light



Bezel / Grommet

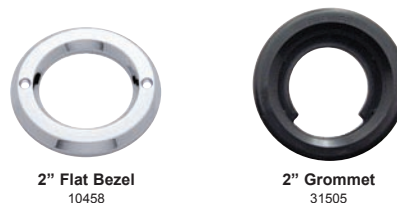

Incandescent Peterbilt Rear Air Cleaner Kit - 2" Light

Description

- Stainless Steel Peterbilt Rear Air Cleaner Kit with 2" Incandescent Lights
- Available with Chrome Light Bezel (Item # 10458), Stainless Steel Light Bezel (Item # 20501) and Rubber Grommet (Item # 31505)
- Stainless Steel Air Cleaner Bracket Available Separately: Item # 31467 (16 Light Cutouts), Item # 31460 (12 Light Cutouts)

2" Incandescent Light x 12

Item Number w/ CR Bezel	Item Number w/ SS Bezel	Item Number w/ Grommet	Incandescent Light	
			Style	Item Number
31484	31485	31461	Flat	30911 x 12

2" Incandescent Light x 16

Item Number w/ CR Bezel	Item Number w/ SS Bezel	Item Number w/ Grommet	Incandescent Light	
			Style	Item Number
31486	31487	31468	Flat	30911 x 16

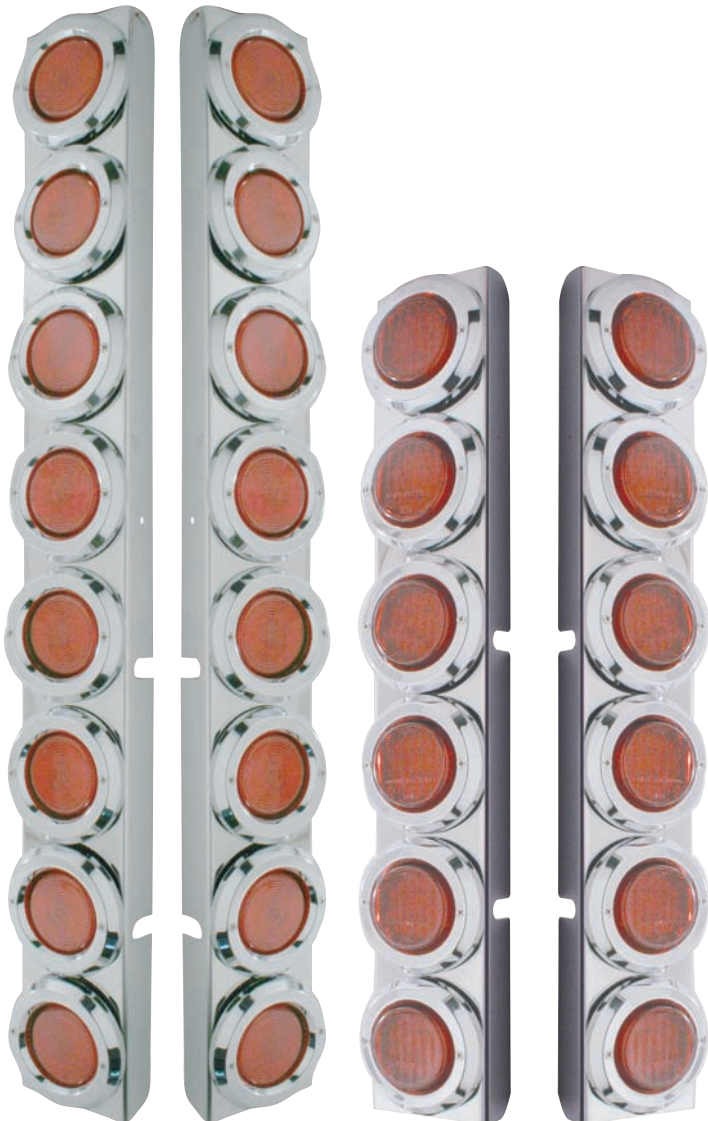

Recommended Accessories

2" Incandescent Light



Flat
30911

Bezel/Grommet



2" Chrome Bezel
10458



2" Stainless Bezel
20501



2" Grommet
31505

Hot Items

High Power LED Work Light



39688 - 12V, 39992 - 12V/24V
6 High Power LED Work Light



39979
6 High Power LED Spot/Utility Light



39901
6 High Power LED Work Light



39993
5 High Power LED Rectangular Auxiliary/Utility Light



37634B
12 High Power LED Rectangular Work/Utility Light



37622B
6 High Power LED Square Work/Utility Light



37597
9 High Power LED Flood Light



37598
9 High Power LED Spot Light

TERMS & CONDITIONS / ORDERING GUIDELINES / FREIGHT

IMPORTANT: PLEASE REVIEW CAREFULLY

New Accounts

Initial minimum buy-in is \$2,000 (or to be determined by United Pacific Industries, UPI hereafter). All initial orders must be prepaid in advance by Cashier's Check or VISA/MC. All new/potential accounts must complete a UPI "New Customer Info/Credit Form" and follow the Dealer Qualification Instructions. Upon completion of the credit application, approved accounts will be assigned payment terms of NET 30 Days (from invoice date). Accounts denied a credit line will be required to prepay in advance by Cashier's Check or VISA/MC.

Payment Terms:

Term Accounts

Accounts with NET 30 Days terms are required to submit payment within the 30 days from the date of invoice. Acceptable forms of payment include checks, ACH (Automated Clearing House), or wire transfer.

A service charge of 1.5% per month will be imposed on invoices not paid within the 30 day term. Delinquent accounts will be required to pay Cash-In-Advance (CIA). Checks will be accepted but orders will not be released until the check is cleared by the bank. Past due invoices will delay current orders. Please check with UPI on your account status when placing an order.

Credit Cards

Accounts denied credit terms may pay by Visa or MasterCard. Credit card will be charged upon shipment. Credit card payments will not be accepted once an order has been shipped. UPI does not accept American Express or Discover card.

COD

A \$9.00 fee will be assessed per COD box for all FedEx/UPS COD shipments. Truck COD shipment fees are to be determined later by trucking company.

Returned Checks:

A \$30 NSF(Non Sufficient Fund) fee will be assessed on each incidence a check is returned to UPI.

ORDERING GUIDELINES

Placing Orders: New orders may be placed by any of the following methods

1. Fax: **(310) 638-6287**
2. E-mail: sales@uapac.com
3. Telephone: In order to minimize errors, customers are encouraged to submit their orders by fax or email. Telephone orders should be limited to smaller orders such as add-ons to orders already submitted and/or fill-ins occurring between larger restocking orders.

Changes to Orders:

Whenever possible, revisions to orders - additions or deletions of items - should also be submitted via fax or email to reduce the possibility of errors.

Additions/Deletion of items will only be accepted within 48 hours after the initial order date and/or before 12:00PM on the date of the shipment.

Additions of items placed after the 48 hours time period will be considered a new order and adhere to a new order freight prepaid policy. Deletions of item cannot happen after the 48 hours time period and/or after 12:00PM on the date of the shipment. Please note additions and/or deletions of items will delay the shipment date.

Canceling Orders:

Cancellation of orders must be submitted via fax or email within 24 hours of the order date. If the order has already shipped it will be the customers responsibility to return the order at the customers own expense. A restocking fee may apply, please see "Return" policy for further detail.

Backorders:

Customers have the option of having their backorders shipped or cancelled. Backorders resulting from a freight prepaid qualifying order will be shipped freight prepaid. UPI reserves the right to cancel backorders that are 6 months or older from the initial invoice date.

Minimum Order:

A minimum order of \$50.00 is required. Orders below \$50.00 will be assessed a minimum order fee of \$10.00.

Packaging:

A 10% service charge will be added to orders with special packaging or UPC barcoding requirements.

Lead Times:

Standard lead time for all United Pacific orders is 1-3 business days from the receipt of the purchase order. Larger orders may require a lead time of up to 5 business days. Transit time of 3-5 business days must be considered when placing orders. UPI cannot be responsible for delays in shipment after an order leaves our warehouse. UPI will work to resolve delays with freight forwarding firms, however, delays do arise from time to time due to weather and unforeseen circumstances beyond UPI's control. Express order are exempted; please view Freight/Shipping Policy for further detail.

Order Confirmation:

United Pacific will acknowledge receipt of orders by email/fax/telephone within 1 business day of receipt. If confirmation is not received, please contact UPI to ensure your order was received.

FREIGHT

Prepaid Freight:

Stock orders between \$50 and \$999.99 (US Lower 48 States), **\$50 and \$2499.99 (Alaska and Hawaii)**, **\$50 and \$1499.99 (Canada)**, [all price net US\$], will be shipped FOB Carson, California. Stock orders of \$1,000 (US Lower 48 States), **\$2500 (Alaska and Hawaii)**, **\$1500 (Canada)**, [based on UPI current pricing], or more will be shipped Freight Prepaid Ground to a single location only. (See exception for Oversize Items*). *Express Air orders, Special Net Pricing orders, and Special Quote Pricing orders are excluded.* United Pacific reserves the right to select the carrier of our choice. Customers may select the carrier of their choice at their own expense, negotiated rates and insurance. If customers elect to choose their own freight carrier, orders will be shipped via FREIGHT COLLECT.

***Oversize Item Freight Policy** - Applies to PB 379 Front Fenders, 60" or longer exhaust, and 18" or longer Saddle Boxes. 2 Options:

1. Freight will be prepaid by United Pacific if the total order of all items exceeds \$4,000 (US Lower 48 States) or **\$5000 (Hawaii, Alaska and Canada)**, [all price net US\$]. There will not be additional charges for these items included on the order.
2. Freight will be prepaid by United Pacific if a customer orders a total of \$2,500 (US Lower 48 States) or **\$3500 (Hawaii, Alaska and Canada)**, [all price net US\$], of PB 379 fenders, 60" or longer exhaust, and/or 18"+ Longer Saddle Boxes only. If the order is below \$2,500 (US Lower 48 States) or **\$3500 (Hawaii, Alaska and Canada)**, United Pacific will add freight charges to the order for the oversize items.

Will Call Orders:

Will Call orders can be picked up 2 - 4 hours after placing the order. Customers should always call ahead to confirm when order will be ready to pick up.

SHIPPING POLICY / CLAIMS

IMPORTANT: PLEASE REVIEW CAREFULLY

SHIPPING POLICY

International Shipments:

Shipments to locations outside the continental United States will be shipped to the customer's shipping agent or broker within the continental United States in accordance with the US freight policy. International customers will be responsible for the duties and taxes of their respective country.

Express Orders:

All express orders, such as Next Day, Second Day, 3 Day Service & Will Call, must be faxed/emailed. Order confirmation will be faxed to the customer for final approval. If confirmation is not received, please contact UPI to ensure your order was received. Customers are required to sign off on express orders and fax confirmation back to UPI. Cut off for express order is 12:00PM. Express orders received after 12:00PM may or may not ship the same day. Please call UPI to confirm projected shipping date or will call time.

Due to the high cost of express shipments, customer may request UPI to call to confirm freight charges. If customer does not request confirmation, UPI will ship the express order.

Drop Shipments:

All drop shipment orders will be assessed a \$10.00 processing fee. Drop shipment processing fee will be automatically added to the invoice without notice. All drop shipment orders must be faxed in. No freight allowance or prepaid freight will be permitted for any drop shipments, thus, all drop ship orders, regardless of order size, are FOB Carson, CA.

CLAIMS

General Policy:

All claims (Shortage, Mis-Shipped, Damage, Overage, Customer Error & Billing Error) must be submitted to UPI within 3 business days of the receipt of shipment. Claims submitted beyond 3 business days of the receipt of shipment will be voided by UPI.

On all shipments, the person who signs and receives the shipment is responsible for noting on the Bill of Lading, in writing, whether any boxes arrived damaged or shorted. Failure to do so will void all claim rights between all parties. UPI will have no recourse against the trucking company if customer does not note any damages or shortages on the Bill of Lading.

The customers receiving department must count and sign for the exact number of boxes received. Failure to follow the above instructions will void all claim rights between all parties.

Shortages / Mis-Ships / Damages

While UPI strives to fill every order with 100% accuracy, on occasion an item may get shipped in error or get damaged during shipping. In the event this occurs, please follow the process below. Note: This type of claim must be reported to UPI within three (3) business days of receiving the order.

- Contact the United Pacific office to initiate the claim. To make it easy for you we have two acceptable methods for requesting the claim:
 - * By e-mail : returns@uapac.com
 - * By fax : (310) 638-6287
 - * **Note: To ensure you receive a timely credit, we cannot accept claim requests by phone.**
- You will be required to provide the following information:
 - * Your business name
 - * Contact name and telephone number (in case we have questions)
 - * Date the order was received

- * A copy of the Packing List / Invoice noting the item number and quantity that was shipped in error or damaged during shipping.
- * Special instructions you have for us.

- UPI will send a return label so you can ship the items back.
- Once we receive the miss-shipped/damaged item(s) a credit will be issued to your account on the next billing cycle.
- Shortages will be credit to the Customers' account, unless customer would like the shortages replaced.

Overages:

UPI strives to provide our customers with the best customer service and products, in turn we would greatly appreciate any help from customer in notifying UPI of any shipping overages. Customers will be offered the option of retaining the merchandise or returning the merchandise to UPI at UPI's expense. If the items are to be returned, an RMA number and return shipping label will be provided.

Customer Errors:

Any item or quantity ordered in error by the customer may be returned by contacting UPI for a RMA No.

- To make it easy for you we have two acceptable methods for requesting the RMA:
 - * By e-mail: returns@uapac.com
 - * By fax: (310) 638-6287
 - * **Note: To ensure you receive a timely RMA credit, we cannot accept RMA requests by phone.**
- You will be required to provide the following information:
 - * Your business name
 - * Contact name and telephone number (in case we have questions)
 - * A list of the items number and quantity ordered in error
 - * Special instructions you have for us
- UPI will review the request to ensure the products are within the return period.
- Once we have validated the request, United Pacific will issue an RMA number to the customer. In issuing the RMA approval, the following conditions will apply :
 - * Returned items are subject to a 20% re-stocking fee.
 - * Return shipping costs are the responsibility of the customer.
 - * Items must not have any retail/price sticker on exterior packaging or they will be returned to the customer at customer's expense and no credit given.
 - * Items must be in good condition with original packaging intact or they will be returned to the customer at customer's expense and no credit given.
 - * Allow up to 30 days for the credit to be issued from the time the returned items are received.

Billing Errors:

Billing errors should be reported to UPI within 3 business days of invoice receipt. Customers are asked to provide the invoice number, part number, and quantities in question. Once verified, UPI will issue a credit or an invoice for the difference in billing error.

WARRANTY POLICY / RETURNS

IMPORTANT: PLEASE REVIEW CAREFULLY

WARRANTY POLICY

General Policy:

UPI offers a NO HASSLE WARRANTY RETURN policy to all our customers. Warranty claims can only be submitted through an authorized UPI Distributor. UPI warranty is not transferable and applies to the original installation and purchase only. In no event shall UPI be liable for incidental or consequential damages, nor shall UPI be liable for any claims or damages arising out of or connected with the UPI warranty exceed the purchase price of the products. There are no warranties, expressed or implied (including any warranty of merchantability or fitness) that extend beyond this warranty. The warranty does not apply to costs associated with the loss of use of the product, loss of time, inconvenience, commercial loss, incidental or consequential damages. UPI reserves the right to alter the designs of products without assuming any obligation to modify previously manufactured products and will only replace warranted products with redesigned products.

Warranty does not apply to merchandise that has been drilled, cut, welded, modified in any way or installed contrary to normal installation and usage. In addition, UPI cannot be held liable for damages caused by road hazards, accidents, misuse, neglect, abuse or corrosive environments including acid washes and highway snow/ice chemicals which can cause discoloration and corrosion in aluminum, chrome, stainless steel and light products. UPI reserves the right to credit returned merchandise at the initial purchase price or at the current selling price, which price ever is lower.

Aluminum / Chrome / Stainless Steel Products:

All aluminum, chrome, and stainless steel products carry a limited 6 month warranty (from invoice date) against defects in material or workmanship.

Lighting Products:

Incandescent

All incandescent lighting products carry a limited 12 month warranty (from invoice date) against defects in material or workmanship. The limited 12 month warranty does not apply to several applications, such as, buses, construction equipment, and off road vehicles.

LED

Please refer to the Master Lighting Product Catalog for more detail.

RETURNS

General Policy:

All returns must be authorized by UPI. All return requests must be faxed or e-mailed (returns@uapac.com) A RMA number (Return Merchandise Authorization Number) will be provided. Returns not possessing a valid RMA number are subject to rejection and will be returned to sender at the customer's expense.

All customers are encouraged to use the Warranty RMA Claim Form.

Defective Goods / Warranty Return:

UPI offers our customers a No Hassle Warranty Return. Please follow the instructions below for requesting a RMA for defective goods:

1. If any warranty issues occur, simply contact the UPI for RMA number To make it easy for you we have two acceptable methods for requesting the RMA:

- * By e-mail: returns@uapac.com
- * By fax: (310) 638-6287

*** Note: To ensure you receive a timely RMA credit, we cannot accept RMA requests by phone.**

2. You will be required to provide the following information:

- * Your business name
- * Contact name and telephone number (in case we have questions)
- * A list of the defective item number and quantity with the nature/reason of the defect
- * Special instructions you have for us
- * The enclosed fax form may be used for your convenience to request an RMA

3. UPI will review the request to ensure the products are within the stated warranty period.

4. Once we have validated the warranty items, a RMA confirmation, listing the items and cost will be faxed to the customer within 3 business days. UPI will process the credit to your account within 30 days.

Note: There will be no need to return the warranty product to us. However, from time to time, UPI may require some warranty products to be shipped back so we may analyze the cause of the failure. All warranty products that are required to be shipped back will be freight prepaid by UPI.

Stock Return

United Pacific Industries encourages all customers to regularly monitor the sales volume and stock level of their inventory items. As sales trends may slow the movement of specific items, our hope is that those items are featured as "close-out specials" as to minimize stock returns. We also understand that the customer, from time to time, may accumulate over-stock items and desire to return those. Therefore, we have adopted the following policy below.

NOTE:

- * Items must have been purchased by the dealer requesting the stock return.
- * Items must have been purchased within the preceding 12 months.
- * Items that have been discontinued will not be considered for return.

1. Contact the United Pacific office for RMA number We have 2 acceptable methods for requesting the RMA:

By e-mail : returns@uapac.com

By fax : (310) 638-6287

Note: To ensure you receive a timely RMA credit, we cannot accept RMA requests by phone.

2. You will be required to provide the following information:

- * Your business name
- * Contact name and telephone number (in case we have questions)
- * A list of defective items: Item numbers and quantity of each
- * Special instructions you have for us

3. Your claim will be reviewed within 5 business days and you will be contacted by your sales representative who will discuss solutions to liquidate these slow moving items.

4. In the event United Pacific and the customer agree to a credit in lieu of returning the items, this credit will be issued within 10 business days.

5. In the event items are returned by the customer, United Pacific will issue an RMA number to the customer. In issuing the RMA approval, the following conditions will apply:

- * Returned items are subject to a 20% re-stocking fee.
- * Return shipping costs are the responsibility of the customer.
- * Items must not have any retail/price sticker on exterior packaging or they will be returned to the customer at customer's expense and no credit given.
- * Items must be in good condition with original packaging intact or they will be returned to the customer at customer's expense and no credit given.

RETURNS / CATALOGS / DISCLAIMER

IMPORTANT: PLEASE REVIEW CAREFULLY

* Allow up to 30 days for the credit to be issued from the time the returned items are received

6. Stock returns may be requested throughout the year and are subject to a maximum of 5% of prior year annual purchases.

Closeout/Discontinue Items:

UPI will not warranty or accept returns on Closeout/Discontinue items.

Procedure:

An inventory of the merchandise being returned must accompany each return. The RMA number should be prominently displayed on each carton/box.

All Returns must be returned freight prepaid.

Ship Returns to:

United Pacific Industries
Attn: Returns Department
1751 E. Del Amo Blvd
Carson, CA 90746

RMA's:

Outstanding RMA's will be automatically cancelled if not used within 30 days of issuance.

CATALOGS

General Policy:

UPI will send a set of catalogs and price lists upon the arrival any new catalogs and price list. Included in the mailing will be a Catalog Order Form in which customers can request additional copies.

Catalog/CD Request:

UPI provides additional catalogs/CD's to our customers free of charge. Customer must submit their request on a UPI Catalog Order Form or add the request to their regular restocking order. Requests for additional catalogs/CD's should be submitted along with the regular restocking orders to avoid additional freight charges. Due to the availability of catalogs/CD's, customer's request may be limited to certain quantity. Catalogs/CD's will be shipped along with the customers' order. Customer may request the catalogs be shipped separately, but customer will be responsible for the freight charge.

Picture Request

All UPI item pictures are taken professionally by our marketing department. Item pictures can be downloaded online at www.uapac.com. Item pictures not posted online can be requested by sending an email to e-mail graphic@uapac.com. All picture requests must state the item no and the format of the picture file, i.e jpeg or high resolution. UPI has over 20,000 SKU's and therefore does not have a CD with all the items.

DISCLAIMER

United Pacific Industries reserves the right to amend or update our Policies & Procedures without notice.

RMA FORM SAMPLE



UNITED PACIFIC INDUSTRIES, INC.
 1751 EAST DEL AMO BLVD.
 CARSON, CA 90746
 TEL: (310) 638-6988
 FAX: (310) 638-6287
 TOLL FREE: (800) 790-6988

DEFECTIVE GOODS / WARRANTY CLAIM FORM

Date: _____
 Company Name: _____
 Address 1: _____
 Address 2: _____
 City, State, Zip: _____
 Contact Name: _____

List defective items below:

Item #	Quantity	Description	Reason for Defect
1			
2			
3			
4			
5			
6			
7			
8			
9			
10			

Any special notes / instructions for United Pacific (list here):

File your claim at:
 By email: returns@uapac.com
 By fax: (310) 638-6287

Note: we cannot accept any phone request

Internal Use Only	
Date Received: _____	Final RMA: _____
RMA Approval Date: _____	Credit Amount: _____
RMA Number: _____	Approved By: _____

CATALOG ORDER FORM SAMPLE



UNITED PACIFIC INDUSTRIES, INC.
 1751 EAST DEL AMO BLVD.
 CARSON, CA 90746
 TEL: (310) 638-6988
 FAX: (310) 638-6287
 TOLL FREE: (800) 790-6988

UNITED PACIFIC CATALOG ORDER FORM

Date: _____
 Company Name: _____
 Address 1: _____
 Address 2: _____
 City, State, Zip: _____
 Contact Name: _____

Item #	Description	Quantity	Total
1	CDKW1 UP INTERIOR PRODUCT CATALOG - KENWORTH, CD ROM EDITION (Limit 5 per order)		
2	CDPB1 UP INTERIOR PRODUCT CATALOG - PETERBILT, CD ROM EDITION (Limit 5 per order)		
3	UCHL1 UP HEADLIGHT LIGHTING PRODUCT CATALOG, 1 ST EDITION (Limit 5 per order)		
4	UCIH1 UP INTERNATIONAL PRODUCT CATALOG, 1 ST EDITION (Limit 5 per order)		
5	UCKW2 UP INTERIOR PRODUCT CATALOG - KENWORTH, 2 ND EDITION (Limit 5 per order)		
6	UCLB1 UP LED REAR LIGHT BAR CATALOG, 1 ST EDITION (Limit 5 per order)		
7	UCLED1 UP LED LIGHTING PRODUCT CATALOG, 1 ST EDITION (Limit 5 per order)		
8	UCLT2 UP MASTER LIGHTING CATALOG, 2 ND EDITION (Limit 5 per order)		
9	UCMKW1 UP MINI KENWORTH INTERIOR PRODUCT CATALOG (Limit 50 per order)		
10	UCMPB1 UP MINI 2005+ PETERBILT INTERIOR PRODUCT CATALOG (Limit 50 per order)		
11	UCNW1 UP NUT COVER & WHEEL PRODUCT CATALOG (Limit 5 per order)		
12	UCPB2 UP INTERIOR PRODUCT CATALOG - PETERBILT, 2 ND EDITION (Limit 5 per order)		
13	UF1208 2009 UP NEW ITEM SUPPLEMENT, ANNUAL, (Dec. '07 - Dec. '08 New Item) (Limit 5 per order)		
14			
15			
16			
17			
18			
19			
20			

Any special notes / instructions for United Pacific (list here):

Please read the following policies for ordering catalogs:
 A) All orders for brochures, catalogs, and price books will be shipped with the customers' next regular order.
 B) If you want your brochures to ship independent of your next order, extra shipping fees will be applied and billed to your account. Please approve the shipping fees by providing a signature below.

Signature X _____

UCF-GAT

PRODUCT INDEX

Item No.	Page No.	Item No.	Page No.	Item No.	Page No.	Item No.	Page No.	Item No.	Page No.	Item No.	Page No.
28200	3	30993	21	33079	19	33723	12	33917	14	34779	18
28201	3	30994	21	33600	10	33724	15	33920	14	34780	18
28202	3	30995	21	33601	10	33725	15	33921	14	34781	18
28203	3	30996	21	33602	10	33726	15	33922	14	34782	23
28204	3	30997	21	33603	10	33727	15	33923	14	34783	23
28205	3	30998	21	33604	10	33728	15	34568	16	34784	23
28209	2	30999	21	33605	10	33729	15	34569	16	34785	23
28210B	4	31460	25	33606	10	33730	15	34570	16	34786	24
28211B	4	31461	26	33607	10	33731	15	34571	16	34787	24
28212	4	31465	15,17	33608	11	33800	10	34572	16	37322	18
28213B	4	31467	25	33609	11	33801	10	34573	16	37323	18
30057	13	31468	26	33610	11	33802	10	34574	16	37330	25
30058	22	31478	23	33611	11	33803	10	34575	16	37331	25
30060	11,14	31479	23	33612	11	33804	10	34576	18	37332	25
30061	21	31480	23	33613	11	33805	10	34577	18	37333	25
30063	21	31481	23	33614	11	33806	10	34578	18	37334	25
30065	13	31482	24	33615	11	33807	10	34579	18	37335	25
30066	22	31483	24	33616	12	33808	11	34580	18	37336	25
30070	21	31484	26	33617	12	33809	11	34581	18	37337	25
30072	10	31485	26	33618	12	33810	11	34582	23	37338	25
30073	21	31486	26	33619	12	33811	11	34583	23	37339	25
30183-1	16,17	31487	26	33620	12	33812	11	34584	23	37340	25
30260	12,14	31630	22	33621	12	33813	11	34585	23	37341	25
30261	21	31631	22	33622	12	33814	11	34586	24	37342	25
30264	21	31632	22	33623	12	33815	11	34587	24	37343	25
30771	21	31633	22	33624	15	33816	12	34668	16	37344	25
30772	21	31634	22	33625	15	33817	12	34669	16	37345	25
30773	21	31635	22	33626	15	33818	12	34670	16	37346	25
30774	21	31636	22	33627	15	33819	12	34671	16	37347	25
30775	21	31637	22	33628	15	33820	12	34672	16	37348	25
30776	21	31638	22	33629	15	33821	12	34673	16	37349	25
30777	21	31639	22	33630	15	33822	12	34674	16	37350	25
30778	21	31640	22	33631	15	33823	12	34675	16	37351	25
30779	21	31641	22	33700	10	33824	15	34676	18	37352	25
30781	21	31642	22	33701	10	33825	15	34677	18	37353	25
30788	21	31643	22	33702	10	33826	15	34678	18	37354	20
30789	21	31974	8	33703	10	33827	15	34679	18	37355	20
30975	21	31975	8	33704	10	33828	15	34680	18	37356	20
30975-1	9	31976	8	33705	10	33829	15	34681	18	37357	20
30976	21	31977	8	33706	10	33830	15	34682	23	37358	19
30977	21	31978	6	33707	10	33831	15	34683	23	37359	19
30978	21	31979	6	33708	11	33900	13	34684	23	37360	19
30979	21	31980	6	33709	11	33901	13	34685	23	37361	19
30980	21	31981	6	33710	11	33902	13	34686	24	37362	19
30981	21	33051	18,20	33711	11	33903	13	34687	24	37363	19
30982	21	33054	18	33712	11	33904	13	34768	16	37364	19
30983	21	33055	18	33713	11	33905	13	34769	16	37365	19
30984	21	33056	18	33714	11	33906	13	34770	16	37366	17
30985	21	33057	18	33715	11	33907	13	34771	16	37367	17
30986	21	33071	19	33716	12	33908	13	34772	16	37368	17
30988	21	33073	20	33717	12	33909	13	34773	16	37369	17
30988-1	7	33074	20	33718	12	33910	13	34774	16	37370	17
30989	21	33075	20	33719	12	33911	13	34775	16	37371	17
30990	21	33076	19	33720	12	33914	14	34776	18	37372	17
30991	21	33077	19	33721	12	33915	14	34777	18	37373	17
30992	21	33078	19	33722	12	33916	14	34778	18	37374	8

PRODUCT INDEX

Item No.	Page No.	Item No.	Page No.	Item No.	Page No.	Item No.	Page No.	Item No.	Page No.	Item No.	Page No.
37375	8	37708	8	39855	8						
37376	8	37709	8	39856	8						
37377	8	37710	8	39857	8						
37378	8	37984	6	39858	8						
37379	8	37985	6	39859	8						
37380	8	37986	6	39860	8						
37381	8	37987	6	39861	8						
37382	8	37988	6	41525	5						
37383	8	37989	6	41526	5						
37384	8	37990	8	41530	4						
37385	8	37991	8	41531	4						
37386	6	37992	8	41532	4						
37387	6	37993	8	41533	4						
37388	6	37994	8	41534	4						
37389	6	37995	8	41535	4						
37390	6	38942B	5	41536	4						
37391	6	38943B	5	41537	4						
37392	6	38944B	5	42019	5						
37393	6	38945B	5								
37394	6	38946B	5								
37395	6	38947B	5								
37396	6	38948B	5								
37397	6	38949B	5								
37462	6	39628	8								
37463	6	39629	8								
37464	6	39630	8								
37465	6	39631	8								
37466	8	39632	8								
37467	8	39633	8								
37468	8	39634	6								
37469	8	39635	6								
37526	2	39636	6								
37527	2	39637	6								
37528	2	39638	6								
37529	2	39639	6								
37530	2	39794	8								
37531	2	39795	8								
37532	2	39796	6								
37533	2	39797	6								
37623	2	39838	6								
37624	2	39839	6								
37655	2	39840	6								
37656	2	39841	6								
37657	2	39842	6								
37658	2	39843	6								
37659	2	39844	6								
37660	2	39845	6								
37699	6	39846	6								
37700	6	39847	6								
37701	6	39848	6								
37702	6	39849	6								
37703	6	39850	8								
37704	6	39851	8								
37705	8	39852	8								
37706	8	39853	8								
37707	8	39854	8								

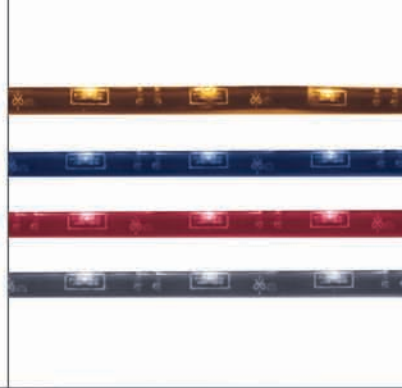

UNITED PACIFIC INDUSTRIES

1751 East Del Amo Blvd.
Carson, CA 90746
Tel: (310) 638-5988 / Fax: (310) 638-6287
Toll Free: (800) 790-6988
www.uapac.com
sales@uapac.com

UCAC1
AIR CLEANER, AIR CLEANER LIGHT
BRACKET & ACCESSORIES



710270095124

UCAC1
Printed in China

